

devention
DEVO-10

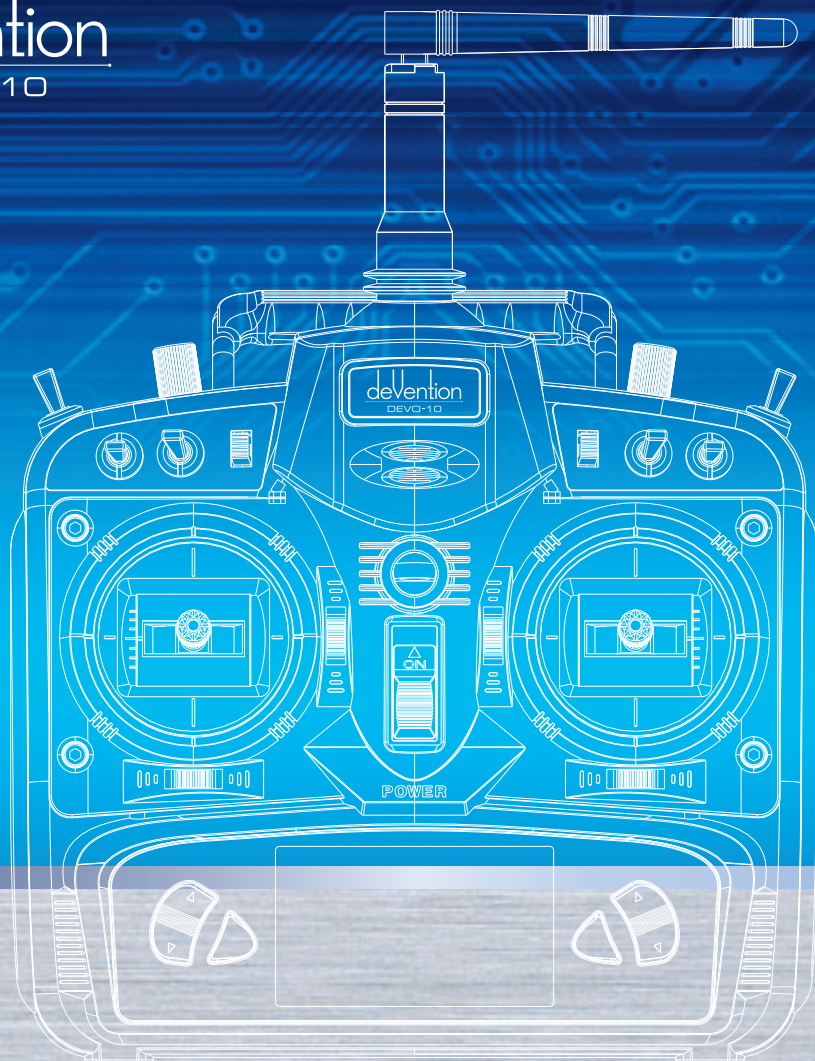

Devo 10

10-channel micro computer system

Users Manual of DEVO-10 transmitter

Note: Please read throughly the manual before using and keep it in a safe place for the future reference.

Contents

Part one: General information

1.0 General information	2
1.1 Important statements	2
1.2 Safety needing attention	2
1.3 Attention before flight	2
2.0 Features	3
2.1 Transmitter DEVO-10	3
2.2 Features of DEVO-RX1002	3
3.0 Specification	3
3.1 DEVO-10 transmitter specification	3
3.2 Receiver specification	3
4.0 Definition of DEVO-10	4
4.1 Panel definition	4
4.2 Rear definition	4
4.3 Wiring Diagram	5
4.4 Function keys in panel	5
5.0 Control Stick Adjustment	5
5.1 The stick length adjustment	5
5.2 Control Stick Tension Adjustment	6
6.0 Neck Strap Usage	6
7.0 Stick Mode Switch	6
8.0 Switches between left-hand and right-hand throttles	7
8.1 Right-hand throttle switched to left-hand throttle	7
8.2 Left-hand throttle switched to right-hand throttle	7
9.0 Training function	8
10.0 Customized fixed ID	10
11.0 Installation requirement for receiver	11
11.1 Receiver Frame rate setting	11
12.0 Installation requirement for DEVO-10 battery pack	12
12.1 DEVO-10 Battery Charging	12

Part two: Helicopter

1.0 System Menu	14
1.1 Language setting	14
1.2 Display	14
1.3 Buzzer warning	15
1.4 Vibrator	15
1.5 Stick Mode	15
1.6 Stick Direction	16
1.7 Stick Calibration	16
1.8 About	16
2.0 Model Menu	17
2.1 Model Select	17
2.2 Model Name	17
2.3 Model Copy	17
2.4 Model wireless copy	18
2.5 Model reset	19
2.6 Type Select	19
2.7 Trim System	19
2.8 Stick Position Switch	20
2.9 Device select	21
2.10 Device Output	21
2.11 Swash Type	22
2.12 Power Amplifier	22
2.13 Fixed ID	23
2.14 Sensor setting	24
3.0 Function Menu	26
3.1 Reverse Switch	26
3.2 Travel Adjust	27
3.3 Sub Trim	27
3.4 Dual rate and Exponential	28
3.5 Throttle Hold	29
3.6 Throttle Curve	30
3.7 Mix to throttle	31
3.8 Gyro Sensor	32

3.9 Governor	33
3.10 Tail Curve	33
3.11 Swash Mix	35
3.12 Pitch Curve	35
3.13 Program Mix	37
3.14 Monitor	40
3.15 Fail safe	41
3.16 Sensor View	41
3.17 Trainer	42
3.18 Timer	44

Part three: Airplane

1.0 System Menu	46
1.1 Language setting	46
1.2 Display	46
1.3 Buzzer warning	47
1.4 Vibrator	47
1.5 Stick Mode	47
1.6 Stick Direction	48
1.7 Stick Calibration	48
1.8 About	48
2.0 Model Menu	49
2.1 Model Select	49
2.2 Model Name	49
2.3 Model Copy	49
2.4 Model wireless copy	50
2.5 Model reset	51
2.6 Type Select	51
2.7 Trim System	51
2.8 Stick Position Switch	52
2.9 Device select	53
2.10 Device Output	53
2.11 Wing Type	55
2.12 Power Amplifier	57
2.13 Fixed ID	57

2.14 Sensor setting	58
3.0 Function Menu	61
3.1 Reverse Switch	61
3.2 Travel Adjust	61
3.3 Sub Trim	61
3.4 Dual rate and Exponential	62
3.5 Throttle Hold	63
3.6 Throttle Curve	63
3.7 Differential	65
3.8 Balance	67
3.9 Gyro sensor	68
3.10 Governor	69
3.11 Aileron to Rudder Mix	69
3.12 Elevator to flap mix	70
3.13 Rudder to aileron/elevator mix	71
3.14 Flap System	71
3.15 Aileron to flap mix	72
3.16 Program mix	73
3.17 Monitor	76
3.18 Fail safe	77
3.19 Sensor View	77
3.20 Trainer	78
3.21 Timer	79
4.0 Upgrading	79

devention

DEVO-10

Part one General information

DEVO-10 takes 2.4 GHz Direct Sequence Spread Spectrum (DSSS) technology and features automatic ID binding, automatic ID assignment, and also features fixed ID set by yourself. The usage of wireless copy function keeps you away from the trouble in wire link-up. Three mode types of helicopter, airplane are available to meet your requirements for different models. Online update via USB ensures a transmitter in hand not to be out of date and makes it full of vigour.

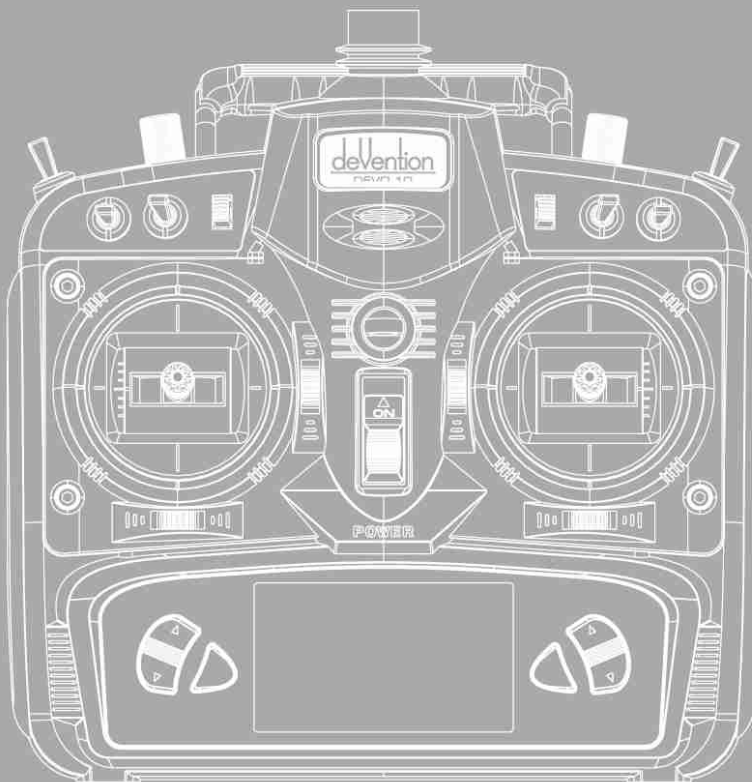

1.0 General information

1.1 Important statements

- (1) The transmitter is suitable for experienced pilots beyond 14 years old.
- (2) Flying the model aircraft in approved ground is a must.
- (3) We are not responsible for any safety caused by operation, usage or control once the transmitter is sold out.
- (4) We consign our distributors to offer technical support and service after sale. Please contact the local distributors for problem solutions caused by usage, operation, maintenance, etc.

1.2 Safety needing attention

- (1) Far away from obstacle and people.

RC aircraft in flights is uncertain of flight speed and status, which potential risk exists in when flying. Please keep your radio controlled aircraft far away from people, high buildings, high-tension line, etc, and avoid operating in rain, storms, thunder and lightening.



- (2) Away from humidity environment

Radio controlled aircraft should be kept away from humidity and vapor because it is composed of complicated precise electronic elements and mechanical parts.



- (3) Proper operation

Use original spare parts to upgrade, modify or maintain your equipment in order to assure its safety. Please operate your equipment within the range of functions permitted. It is forbidden to use out of the safety laws or regulations.

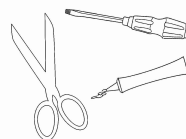

- (4) Safety operation

Operate your equipment according to your body status and flight skills. Fatigue, listlessness and mis-operation will increase the possibilities of accidental hazard.



- (5) Away from heat sources

The inside of the transmitter is composed of precise electronic components and mechanical parts. Keep it far away from heat sources and sunshine to avoid distortion, or even damage caused by high temperature.



1.3 Attention before flight

- (1) Ensure the battery packs of both transmitter and receiver are fully saturated.
- (2) Ensure both the throttle stick and the throttle trim of your DEVO-10 stay at the lowest positions before operation.

- (3) Strictly obey the order of TURN-ON and TURN-OFF before operation. When starting your flight, turn on your DEVO-10 first, and connect the battery to the aircraft last. When turning off the aircraft, disconnect the battery first, and turn off your DEVO-10 last. An upset in the order may cause your aircraft out of control. Cultivate a correct habit of turn-on and turn-off.
- (4) Ensure whether the directions and actions of all the servos in your RC aircraft are correct when executing commands of the transmitter. Using broken servos will result in unforeseen dangers.

2.0 Features

2.1 Transmitter DEVO-10

- (1) The DEVO-10 adopts 2.4 GHz Direct Sequence Spread Spectrum (DSSS) technology and features automatic ID binding and ID assignment. It can also be customizedly set as fixed ID code.
- (2) USB online update makes you always enjoy the latest program.
- (3) Hi-frequency output power is adjustable.
- (4) Wireless data transmission between two DEVO-10 helps experience the training function.
- (5) Up to 30-model data can be saved.
- (6) DEVO-10 adjusting the gyro sensitivity makes hovering flight and fancy flight in an easy way.
- (7) Shape design accords with human engineering and provides comfortable holding.
- (8) Both the length and tension of the sticks can be amendable.
- (9) DEVO-10 can be freely switched among Modes 1, 2, 3, and 4.
- (10) DEVO-10 is suitable for helicopter and airplane. In the helicopter mode, there are three flight modes, each of which can be freely set and its parameters can be personalizedly adjusted to meet the requirement for F3C or 3D aerobatic flight.

2.2 Features of DEVO-RX1002

- (1) Adopts 2.4GHz Direct Sequence Spread Spectrum (DSSS) that features fast reaction and strong anti-jamming protection.
- (2) Double receiving circuits and signal switch automatically effectively assure the stability of receiving signal.
- (3) The single chip Micro as CPU provides super-strong analyzing ability.
- (4) The receiver maintains the frequency and the ID memories when its changing a new battery pack with the transmitter powered on .
- (5) It can be customizedly set as fixed ID and automatic ID assignment.

3.0 Specification

3.1 DEVO-10 transmitter Specification

- Encoder 10-channel micro computer system
- Frequency 2.4GHz DSSS
- Output power ≤ 100 mW
- Current drain ≤ 200 mA (100 mW)
- Power supply 5# Battery 8 X1.5V or NiMH 8 X1.2V 1,600 - 2,000 mAh
- Output pulse 1000 – 2000 Ms (1500Ms Neutral)

3.2 Receiver specification

- Type 2.4GHz 10 channels
- Sensitivity - 105 dbm
- Frequency interval ≥ 4 M
- Weight 9.5 g
- Dimension 37X28X14.5mm
- Receiver Battery 4.8-6V 1,300mAh

4.0 Definition of DEVO-10

4.1 Panel definition



4.2 Rear definition



(1) Charge socket (CHG): input DC at 12V, Current 50 mA; Polarity: $\oplus \rightarrow \ominus$

(2) Digital Signal Converter socket (DSC): used for simulator flight practice via computer (You need software and its dongle which are available in hobby shops), and for training.

(3) USB socket: The USB socket combined with PC machine can upgrade the device program, upload and download the Configuration parameters.

4.3 Wiring Diagram

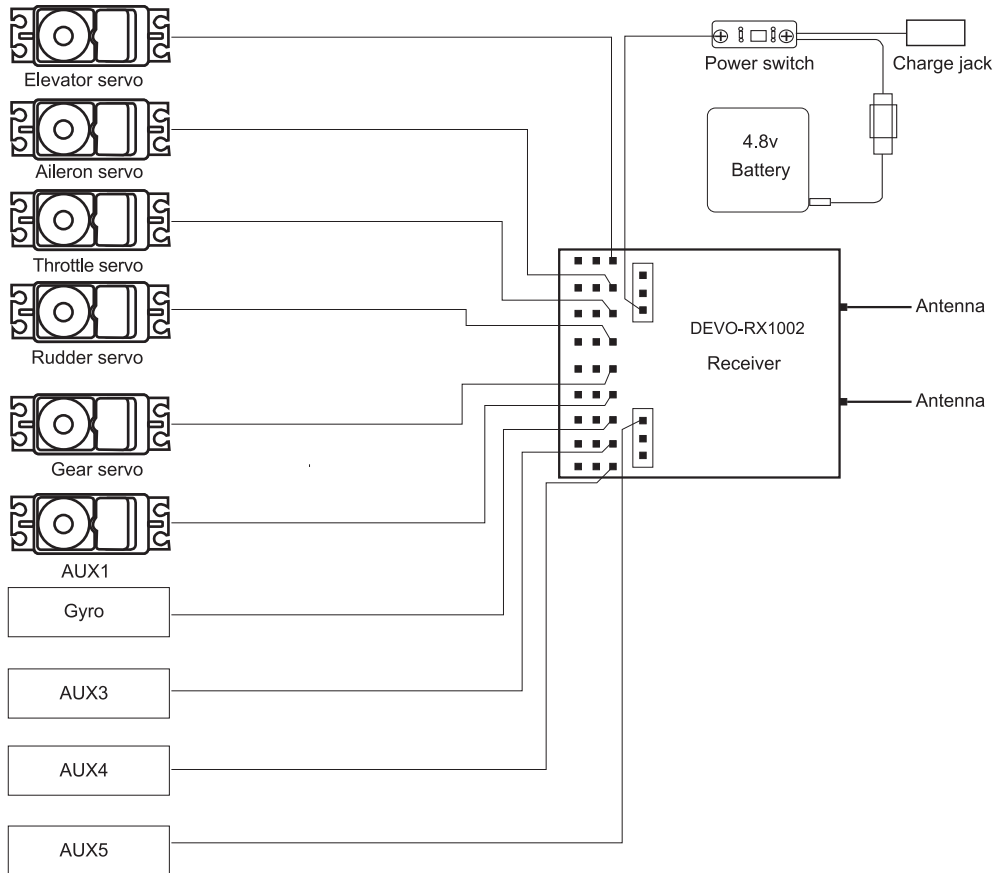

4.4 Function keys in panel

There are 6 functional keys in the panel of DEVO-10. Below are the details:

- (1) EXT: Reset key. Press EXT to exit the main menu.
- (2) ENT: Confirmation key. Press ENT to access the system or the function mode.
- (3) UP: Moves cursor up to the forward function item.
- (4) DN: Moves cursor down to the next function item.
- (5) R: Moves cursor right to increase the setting value.
- (6) L-: Moves cursor left to decrease the setting value.

5.0 Control Stick Adjustment

Stick adjustment control has two parts: the stick length and degree of tightness.

5.1 The stick length adjustment

- (1) Prolong the stick length: Counter clockwise rotate the stick head until the length you hope, and then counter clockwise tighten the stick sleeve.
- (2) Shorten the stick length: Clockwise rotate the stick sleeve until the length you hope, and then clockwise tighten the stick head.

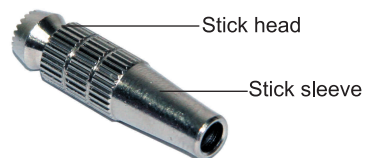

5.2 Control Stick Tension Adjustment

Use the screw driver to loosen the 6 screws in the back cover, (Be careful not to break the wires). Then use a Phillips screwdriver to adjust each screw on the throttle arresting spring for the desired tension (Note: CW rotate to tighten the stick and CCW rotate to loosen).

Control Stick Tension Adjustment Screw

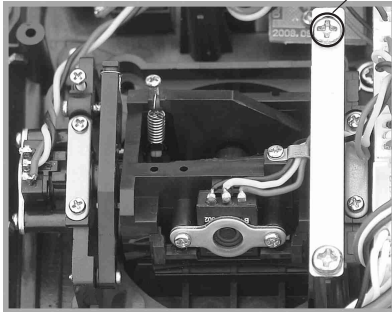

Right throttle set

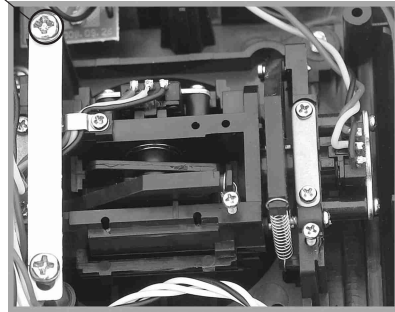

Left throttle set

6.0 Neck Strap Usage

The neck strap can be hooked on the face of the transmitter. The Hook located at the center helps to get optimal balance of the transmitter.



Neck Strap Eyelet

7.0 Stick Mode Switch

There are total four stick modes from MODE 1 through MODE 4. The left-hand throttle includes MODE 2 and MODE 4, and the right-hand throttle includes MODE 1 and MODE 3. Below is the sketch map:



MODE 2



MODE 4

MODE 2 and MODE 4 are listed in left-hand throttle.

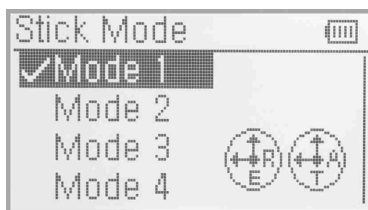

MODE 1



MODE 3

MODE 1 and MODE3 are listed in right-hand throttle.

8.0 Switches between left-hand and right-hand throttles

The throttle switch between the left hand and right hand will be successful if both the MECHANICAL switch and ELECTRONIC switch are finished, separately. Below are the methods for switching:

8.1 Right-hand throttle switched to left-hand throttle

(1) Mechanical switch

Remove the battery and 6 fixed screws in the back cover of Transmitter, and remove the transmitter back cover (Be careful not to break the wires).The internal conditions of the left and right throttle are showed in the following pictures. Then use a Phillips screwdriver to release the connecting rod fixed screw\screw F\screw G and throttle arresting slices in the right throttle position,and fix them up in the corresponding left hand Throttle position.According to personal feeling to adjust screw F(adjust the Throttle stick to desired tention),then fixed up the transmitter back cover.

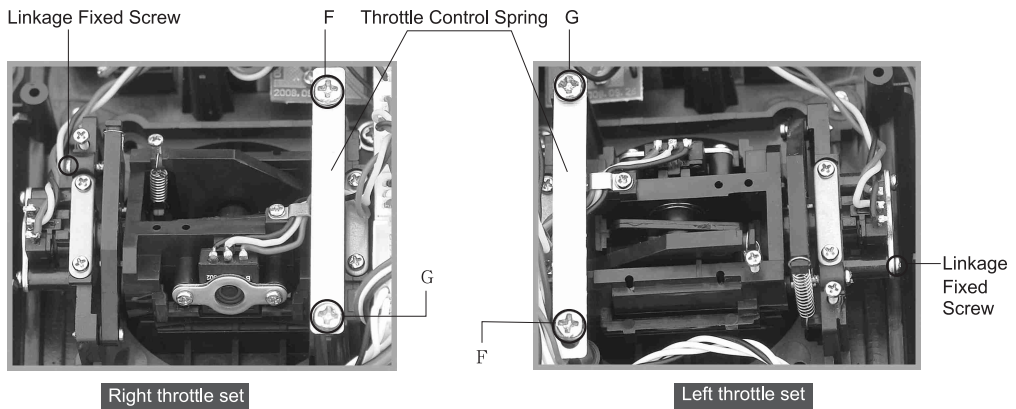

(2) The ELECTRONIC switch

In the main interface,press ENT to access the main menu;Press UP\DN to choose "system menu";Press UP\DN to choose "stick model" and access via "ENT" key,or to choose "model 2\4" and confirm via ENT key,make a mark "✓" before the choosed model.Press EXT to exit after setup complete.



Through the mechanical and electronic switch,the right hand throttle switch to the left hand successfully and can be used normally.

8.2 Left-hand throttle switched to right-hand throttle

(1) Mechanical switch

Refer to the above "Mechanical switch" to open the transmitter cover.

See the following pictures to learn the internal conditions of the left and right hand stich. Then use a Phillips screwdriver to release the connecting rod fixed screw\screw F\screw G and throttle arresting slices in the left hand throttle position,and fix them up in the corresponding right hand Throttle position.According to personal feeling to adjust screw F(adjust the Throttle stick to desired tention),then fixed up the transmitter back cover.

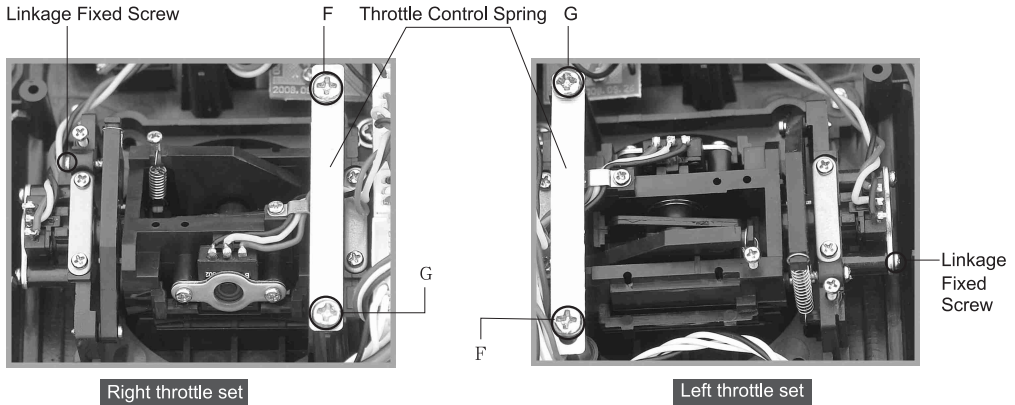

(2) The data switch

Refer to the steps of “8.1 right hand throttle switch to the left hand ,(2)electric switch”,access to “stick model”. The left hand throttle switch to the right hand. There are 4 stick models can be choosed at the stick position. Press UP/DN to choose “model 1\3” and confirm via ENT key,make a mark “√” before the choosed mode.Press EXT to exit after setup complete.The data can be switched automatically.

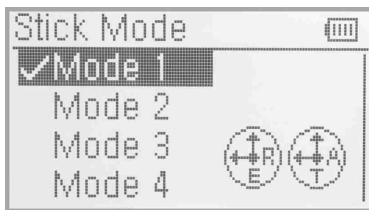

The switch from left hand throttle to right is completed and your DEVO-10 is ready for normal flying.

Note: Pay attention to the strength when removing and adjusting the screws. Excessive strength may damage them.

9.0 Training function

Two DEVO-10 transmitters working together can execute the training function to meet the requirements for the beginner. The setting method is shown as below:

(1) Data copy

First, use the wireless copy function between two DEVO-10 to copy the main transmitter's model data to the trainee's transmitter, this promise the the model data between two transmitters is same. Refer the copy method to the second part of helicopter “2.4 model wireless copy” and do the following steps:

(2) Linkage

Insert the signal wire from the trainer's transmitter into the DSC socket of the trainee's transmitter. Turn on the transmitter and a linkage icon will be shown on the boot screen.

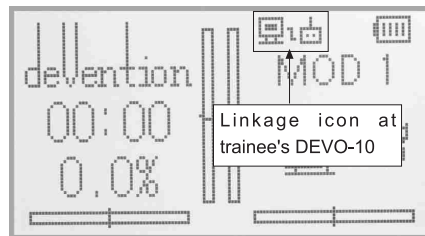

linkage icon

Turn on the power of the trainer's radio. Find out the trainee's model data, and then let the trainer's Radio bind with the aircraft model and fly it normally. Then turn off the power.Insert the other end of the digital signal wire into the trainer's DEVO-10, and then turn on its power. A linkage icon will be shown as below:



Trainee is off and trainer is working

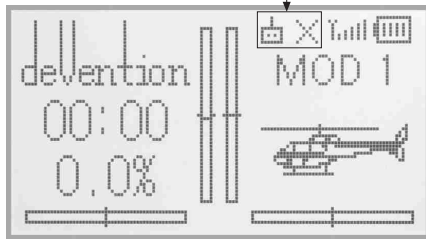

Trainee is working and trainer is off

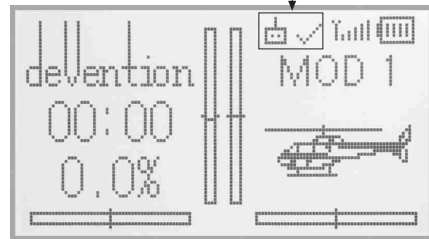

Trainer icon

Training status display: when the trainer's icon becomes into "X", the trainee stops flying and the trainer is working; when the trainer's icon turns into "✓", the trainee is flying and the trainer is in leisure.

(3) Usage method

The training switch can be freely switchable between Left trim and Right trim. The default setting is Right trim. Shown as below:



During flight, if the trainer pushes Right Trim once, the linkage icon will be shown as "✓" that means the control right is moved to the trainee from Trainer. If trainer pushes Right Trim once again, the linkage icon will be shown as "X" that means the trainer takes back the control right from the trainee.

(4) Setting for training function channels

Trainee is available to get full or part of flight control power to the aircraft model via setting the training function channel in the trainer's radio. Below is the setting method:

Press the ENT key to enter main Menu, and then press UP or DN to get access to function menu. Then press UP or DN to select "training function" and press ENT key to enter Trainer interface. The available channels are shown below, and the current status of trainer switch is also shown there.



Trainer switch selection: Press UP or DN to select the switch option; press R or L to select the switch which you want. It includes right and left trim. The default setting is Right trim.

Channel selection: Press UP or DN to select the channel option; Press R or L to select the channel(s) which you want to grant to trainee. The channel(s) you have selected will be activated as "Active". The channels which are not granted to trainee will be kept inhibited. The default setting is "Inhibit".

Press EXT to exit.

10.0 Customized fixed ID

This setting will bind DEVO-10 with its receiver in a unique corresponding relationship. It will greatly speed up the time of automatic binding when DEVO-10 powered on.

(1) Setting for fixed ID

The setting for fixed ID should be under the status that automatic ID binding is successfully finished. Below is the setting method.

Press ENT to enter the main Menu and press UP or DN to move the navigational mark to select Model menu. Press ENT to enter Model Menu. Press UP or DN to select Fixed ID and press ENT to enter the Fixed ID setting interface.

If you want to activate the fixed ID settings, press R or L to change the status from off to ON. A series of random digits will be shown below after change to On.

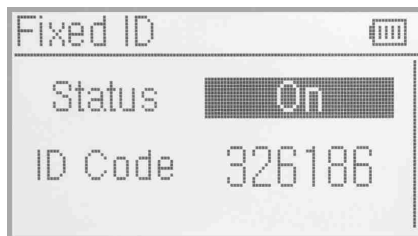
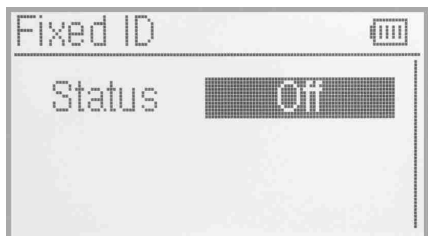

Press UP or DN to choose the ID code setting, press R or L to choose the digits, press UP or DN to move to the next code setting . there are 6 digits can be setted.

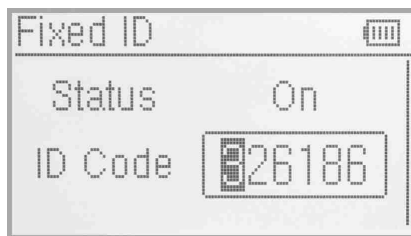

Press ENT key after the new ID has been setted. An inquiry interface of "Are you sure?" pop up. "ID Code Matching" will be shown after press ENT. After matching, the interface will be returned to Model Menu.

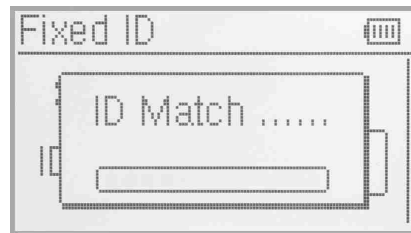
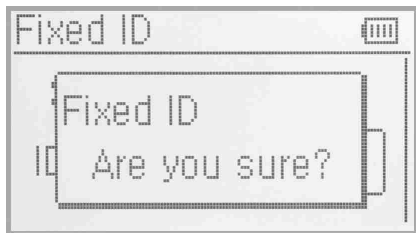

(2) Fixed ID cancellation

Insert the assorted BIND PLUG into the output terminal of BATT before the receiver is powered on, and then plug 5V DC power into other output terminal. The red light of receiver will flash slowly. This means the fixed ID code has been cancelled. Pull out bind plug. DEVO-10 also needs to make relative cancellation and revision after the fixed ID in receiver is cleared out.

In the main interface press the ENT to enter Model Menu and then press UP or DN to move the navigational mark to select MODEL MENU. Press ENT to enter MODEL MENU. Press UP or DN to select Fixed ID code and press ENT key to enter the Fixed ID code interface. Press UP or DN to select STATUS option, Press R or L to change the status to Off. Then press EXT to exit.



11.0 Installation requirement for receiver

- (1) It is important to correctly mount your radio system in your model. Below are some advices on how to install your equipments.
- (2) Wrap the receiver with 10mm thickness polyfoam and fix it with a rubber band or magic string on your helicopter or airplane. It helps protect the receiver.
- (3) It is necessary for you to use rubber grommets and copper sleeves to isolate the vibration from the main body. The mounting screws cannot be over-tightened. Otherwise, the rubber grommets will be distorted and decrease the vibration absorption effect.
- (4) When mounting the servos, make sure the servos' bell cranks can move freely over their whole travel range and ensure the control linkages don't touch or impede the movement of the servos.
- (5) If installing various switches, please keep them far away from the engine tuned pipe and high vibration sources. Ensure all the switches move freely over their whole range.
- (6) Don't make the receiver antennas wrapped or parallel, keep the two antennas form 90 degrees angle.



11.1 Receiver Frame rate setting

There are 11 Millisecond and 22 Millisecond Frame Rate. When using 11 Millisecond frame rate, it can't be compatible with Analog servos. Please select the 22 Millisecond Frame Rate if use Analog servos.

(1) LED Indicator

- Red LED indicates 22ms frame rate;
- Blue LED indicates 11ms frame rate;
- Red&Blue LED indicate the frame rate is under setting;
- Red& Blue LED flash means both frame rate can be set;

(2) Setting method

After TX and RX binding, press the switch with the tool pen or screwdriver, both indicators will turn on. About 5 seconds, both indicator will flash, then release the switch and press it once again, the frame rate can be changed and the indicators will turn red or blue only. Red means 22ms frame rate and Blue means 11ms.

12.0 Installation requirement for DEVO-10 battery pack

Open the battery cover of DEVO-10 transmitter and take out the battery box. Then put 8 cells AA battery or the same size full charged NIMH battery into the battery box. Please check again to make sure the polarities are correct.

Warning: Do not put the polarities of batteries in the opposite directions.

When insert the battery box connector to the transmitter connector, please make the fool proof is right, showing as below picture. Then put the battery box back to battery case.

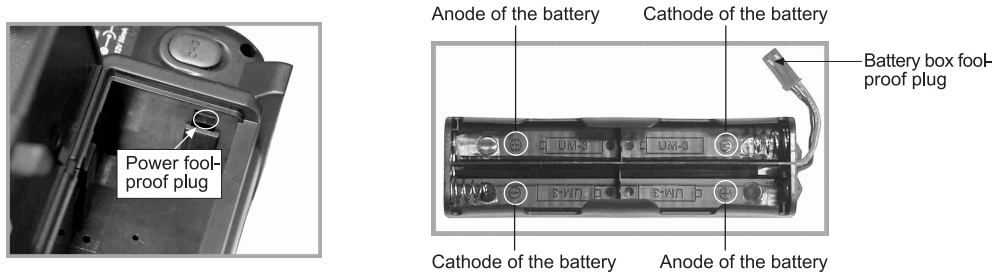

Note: If you don't use the transmitter, please take out the battery.

12.1 DEVO-10 Battery Charging

Warning: the CHG socket is only used for the rechargeable NIMH batteries. If using the batteries which is unchargeable. The CHG socket is not allowed to use.



Charge socket (CHG): input DC at 12V, 50mA; Polarity: ⊕ → ⊖

devention

DEVO-10

Part two Helicopter

All the functional settings, which are relative to the operation system of DEVO-10 itself, are fully integrated in System Menu. They include Language, Display, Buzzer, vibrator, Stick Mode, Stick Direction, Stick calibration, and About.

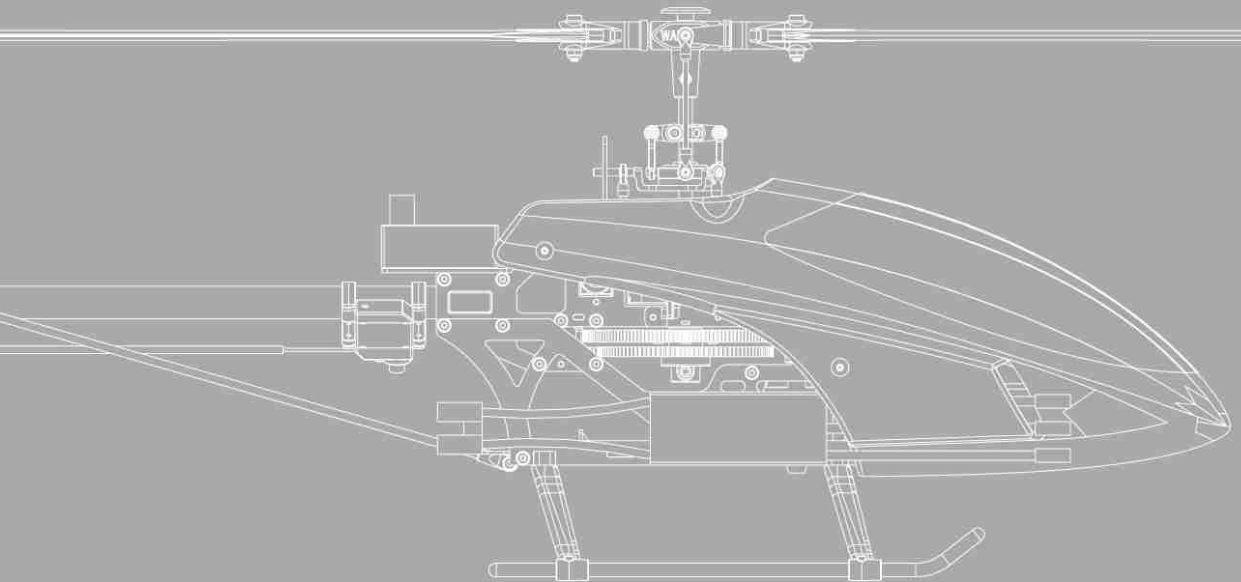

1.0 System Menu

All the functional settings, which are relative to the operation system of DEVO-10 itself, are fully integrated in System Menu. They include Language, Display, Buzzer, vibrator, Stick Mode, Stick Direction, Stick calibration, and About.

Below is the boot screen of helicopter:

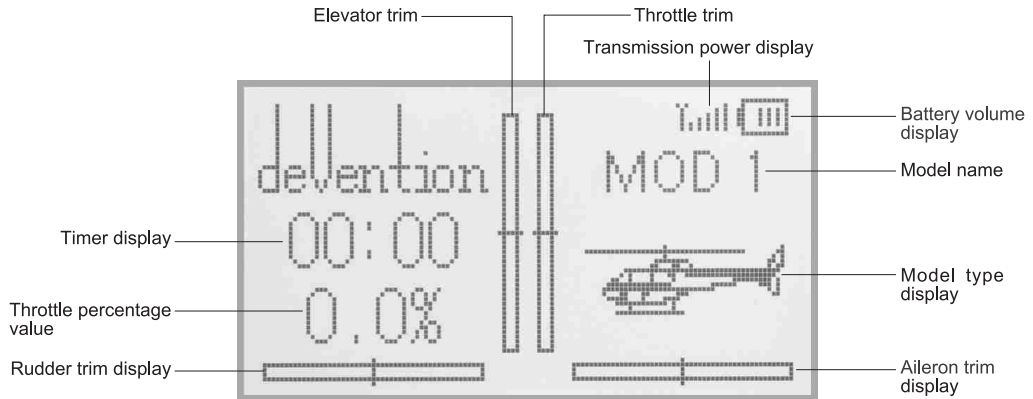

1.1 Language setting

Press ENT to enter System Menu and then press UP or DN to move the navigational mark to select System menu. Then push ENT to enter System menu. Press UP or DN to select Language and press ENT to enter the language interface. Press UP or DN to select the language that you want. A "✓" will be shown on the screen after selected. Push EXT to exit.



1.1 Language setting

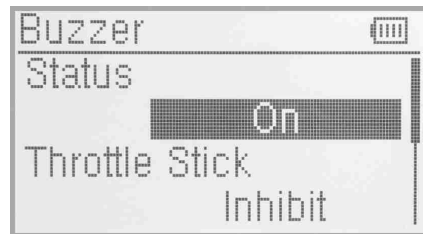

1.2 Display

1.2 Display

Press ENT to enter the main menu and press UP or DN to move the navigational mark to select system menu. Press ENT to enter System Menu and then press UP or DN to select Display to enter "Display" interface. Three items are available to be set. Below are the setting methods for them:

- (1) Backlight contrast: the backlight contrast is adjustable by pushing UP or DN to move the navigational mark to the digits after Contrast. Press R key to increase the backlight contrast, while press L to decrease it.
- (2) Backlight lightness: the backlight lightness is adjustable by pressing UP or DN to move the navigational mark the digits after Lightness. The power consumption will be increased if the backlight lightness is too bright and the battery cruise duration will be shortened. Press R or L to increase or decrease the lightness. When the value is one means turn off the backlight.
- (3) Backlight time out: it is possible to set the duration which LCD stays at highlight in the form of "Always on" or any period from 5 to 60 seconds with an interval of 5 seconds. Press UP or DN to move the navigational mark to select the digits after Timeout. Press L to short the time of backlight duration or keep it in the form of "Always on" while push R or prolong the time. The maximum is 60s.

Press EXT to exit.

1.3 Buzzer warning

Pressing ENT to enter the main menu and pressing UP or DN to move the navigational mark to select system menu then pusing ENT to enter System menu. Pressing UP or DN to select Buzzer and pressing ENT to enter the buzzer interface.



(1) Status: There are On and off two status on the Buzzer interface. Pressing UP or DN to move the navigational mark to the status option. Pressing R or L to change the ON or OFF status. It includes Thro stick, knobs and Tones items under the status is ON.

- (2) Throttle stick buzzer: Pressing UP or DN to move the navigational mark to Thro Stick item then pressing R or L to change the status from inhibit to Active. When Buzzer is at the status of On, if Throttle Stick is set as "Active", a relative musical scale will make response when moving the throttle stick. You can judge the position of the throttle stick according to the different musical scales. Also, it can be set as Inhibit. Press UP or DN to move the navigational mark to Thro Stick item and push R or L to change the status from Inhibit to Active.
- (3) Knobs midpoint Buzzer: When Buzzer is at the status of On, if Knobs is set as "Active", there is buzzer sound when you turn the AUX4 and AUX5 to the midpoint. If you don't need the buzzer sound, please change the status to Inhibit.
- (4) Buzzer tone: the tone is composed of 10 grades. You can choose the favorite one according to your interests. Press UP or DN to move the navigational mark to Tone item and press R or L to make a listening test.

Press EXT to exit.

1.4 Vibrator

The vibrator used as an alarm function to remind the users.

Press ENT to get the Main Menu, press UP or DN to select System Menu. And then press ENT to get System Menu, press UP or DN to select Vibrator. Press ENT to get Vibrator setting interface. There are two status as Inhibit and Active. Press R or L to select Active if need.

Press EXT to exit after finished.

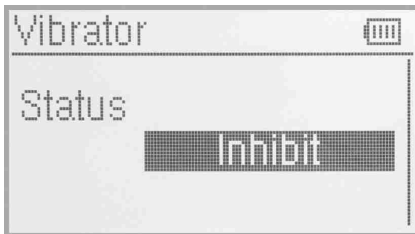

1.5 Stick Mode

Press ENT to get Main Menu, press UP or DN to select System Menu, and then press ENT to the System Menu, press UP or DN to select Stick Mode, and press ENT to get stick Mode setting interface.





Select the stick mode according to the throttle mode showing on the screen. Devo-10 offers 4 stick modes, please refer to “8.0 Switches exchange between left-hand and right-hand throttles.

Press EXT to exit after finished.

1.6 Stick Direction

Press ENT to get Main Menu, press UP or DN to select System Menu, and then press ENT to the System Menu, press UP or DN to select Stick Direction, and press ENT to get stick direction setting interface.

Stick Direction: There are four items available as Elevator, Aileron, Throttle and Rudder. Press UP or DN to select the stick which will change direction, and press R or L to change the direction. The factory setting is Normal.

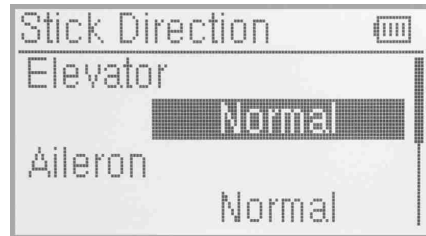

1.7 Stick Calibration

It is a function to re-calibration when stick unusual.

Calibration method:

Press “ENT” to the Main Menu, press UP or DN to select System Menu, then press ENT to System Menu. Press UP or DN to select Stick Calibration and press ENT to the Stick Calibration setting interface. Press ENT to enter Calibration, and below interface shows:

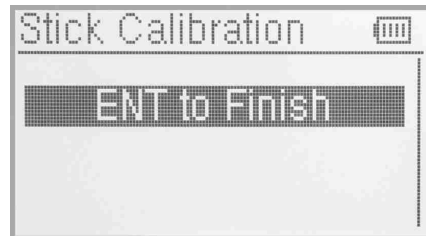
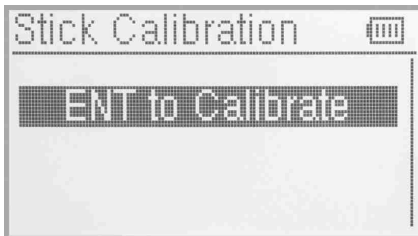

Clockwise or counter clockwise mechanically move the right stick and left stick from minimum levels to maximum levels several times, and then return the stick to the neutral positions, respectively. It will show the calibration is successful after you press ENT to confirm.

Press EXT to exit after finished.

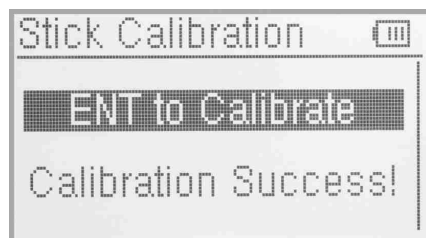

1.8 About

Press “ENT” to the Main Menu, press UP or DN to select System Menu, then press ENT to System Menu. Press UP or DN to select About and press ENT to the About setting interface.

Press EXT to exit after finished.

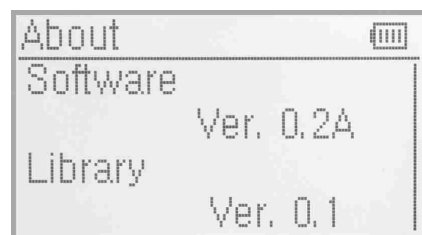

2.0 Model Menu

Model Menu manages all the model data saved in DEVO-10. It includes Model Select, Model Name, Model Copy, Model Transmit, Model Receive, Model Reset, Type Select, Trim System, Stick Position Switch, Device Select, Device Output, Swash Type, Power Amplifier, Fixed ID and Sensor setting.

2.1 Model Select

Press ENT to get Main Menu and press UP or DN to make Model Menu is selected. Press ENT to get the Model Menu and press UP or DN to select Model select, press ENT to get the Model Select setting interface.

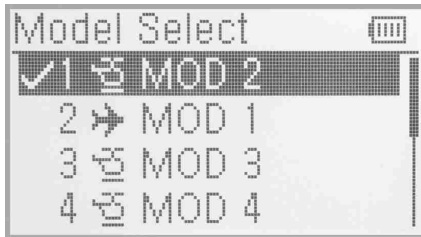

Press UP or DN to select the model you desired, press ENT to confirm and marks "✓" in the front of selected one. Total 30 models are optional. Press EXT to exit after finished.

2.2 Model Name

In the menu of model name, you can make a desired name for your model for long term storage. Its data can be directly withdrawn in next flights. Repeat the step "2.1 Model Select" to choose the model you want to name or save, press EXT to back to the interface.

Press "ENT" to enter Main Menu, press UP or DN to select "MODEL Menu", then Press "ENT" to enter Model Menu; Press UP or DN to select "Model NAME" and then press "ENT" button to get the "Model Name" setting interface.

Press UP or DN to select the character and figure which are needed to be changed, press R or L button to change the character and figure, and press UP or DN to set next one. Press EXT to exit after finished.



2.3 Model Copy

Press ENT to get "Main Menu" and press UP or DN to make "Model Menu" is selected. Press ENT to get "Model Menu" and press UP or DN to select "Model Copy", press ENT to the "Model Copy" setting interface.

Press UP or DN to choose the model you want to be copied as source model and press ENT to confirm, The serial No. and model name of Source Model will be shown as below Illustration.

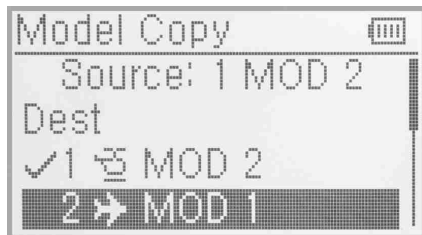
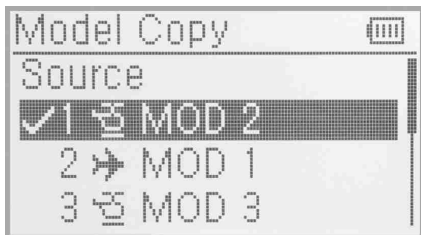

Then press UP or DN to locate the source model, press ENT to confirm. Then an enquire "Are you sure?" is popped up as below Illustration. Press ENT to copy, or press EXT to exit.

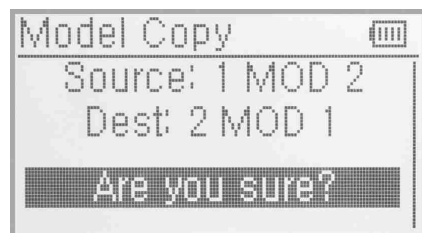

2.4 Model wireless copy

The model data between two DEVO-10 equipments can be wirelessly copied via Model Transmit and Model Receive in Model Menu.

(1) Model transmission

Press ENT to enter "Main Menu" and press UP or DN to select "Model Menu". Press ENT to get "Model Menu" and press UP or DN to select "Model transmission", continue to press ENT to enter "Model Transmit" setting interface.

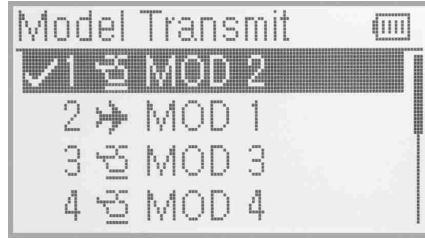

Press UP or DN to choose the source model which will be transmitted, and press ENT to confirm, an enquiry information "Are you sure?" will be shown as below Illustration.

Press ENT to transmit, "Transmitting" appears in the interface. Or press EXT to exit, Press EXT to exit after another DEVO-10 received the data.



(2) Model receiving

Press ENT to enter Main Menu and press UP or DN to select Model Menu. Press ENT to get Model Menu and press UP or DN to select Model Receiving, continue to press ENT to enter Model Receive setting interface. An enquiry information "Are you sure?" will be shown as below Illustration.

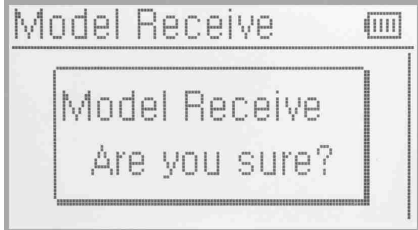

Press ENT to receive, "Connecting" and "Receiving" will be shown in series in the interface. The information of "Received" with the model name will be shown after receiving is finished. Or press EXT to exit.

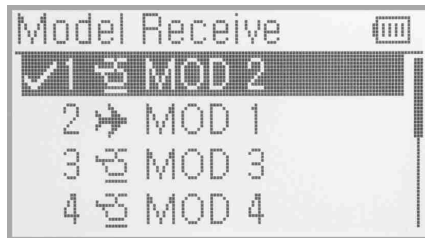
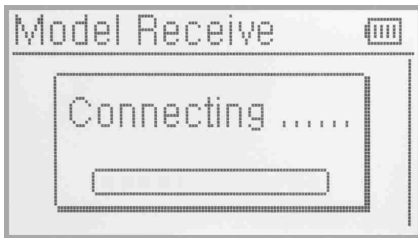

Press UP or DN to choose the save position, an enquiry information "Are you sure?" is shown after press ENT. Press ENT to save or press EXT to exit.

Press EXT to exit after finished.

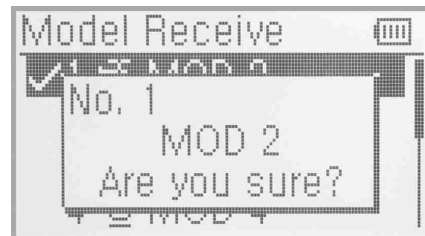

2.5 Model reset

All the model data can be restored to factory settings via Model Reset.

Press the ENT to get Main Menu and press UP or DN to select Model Menu. Press ENT to get Model Menu and press UP or DN to select Model Reset, press ENT to get Model reset setting interface.

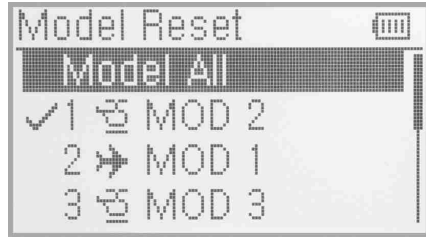

It is possible to store up to 30 models data in the model list of DEVO-10 equipment. There are two methods to reset the model data: batch reset and single reset.

Batch reset: press UP or DN to select All Models, an enquiry information "are you sure?" will be appears in the interface. Press ENT to reset all models, or press EXT to exit.

Single reset: Press UP or DN to choose the model you want to restore, "Are you sure?" will appear after press ENT. Press ENT to reset or press EXT to exit.

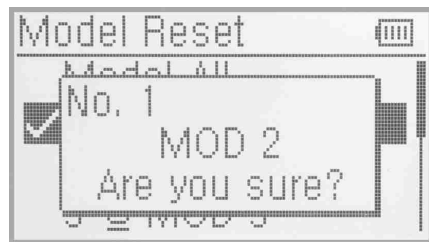

Press EXT to exit after finished.

2.6 Type Select

This device offers two model types menu. They are helicopter and airplane respectively.

Press ENT to get Main Menu and press UP or DN to select Model Menu. Press ENT to enter and press UP or DN to select Type Select and press ENT to enter setting interface.

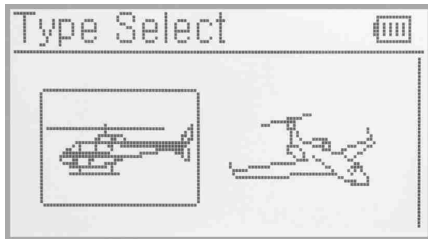

Press "ENT" button to get Helicopter and Airplane selections and press UP or DN to select and press ENT to confirm, then press EXT to exit.

2.7 Trim System

Trim System is able to finely tune the following six items, respectively: Elevator, Aileron, Rudder, Throttle, Left Trim and Right Trim. The trim range is divided into 20 grades (factory default is set at 4). It is convenient to subtly modify the pitch by adjusting the trim range.

Press ENT to get Main Menu and press UP or DN to select Model Menu. Press ENT to enter and press UP or DN to select Trim System, press ENT to enter setting interface.

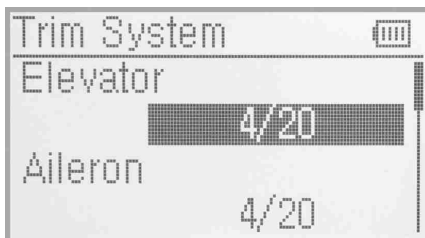

Press UP or DN to select the trim which will set, press R to increase the trim value and press L to decrease. For elevator, aileron, and rudder, there are two more options: Normal and Limited, press R or L you can change the setup. "Normal" means the trim is always working although the corresponding stick stays anywhere. "Limited" means the trim is out of working when the corresponding stick is at maximum position.

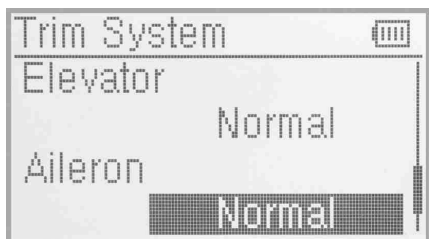

Press EXT to exit after finished.

2.8 Stick Position Switch

According to the following setting, the switch can be used as a switch. The turn-on or turn-off position at which stick stays can also be settable.

Method for setting:

Press the ENT to get Main Menu and press UP or DN to select Model Menu. Press ENT to get Model Menu and press UP or DN to select Stick Position Switch, press ENT to get Stick Position Switch setting interface.

There are four options under the Stick position switch: SPS0, SPS1, SPS2, SPS3. Press R or L to choose the switch you want to define.



Press UP or DN to inhibit channel in navigation mark, and press R to expand the menu. The channel includes four items: Elevator, Aileron, Throttle and Rudder. The factory default is Inhibit. Take Elevator for example.

Press R or L to choose the Elevator as stick, then Press UP or DN to move navigation mark to value of position. It's possible to adjust the stick position via pressing R or L.



Press UP or DN to navigate the OPEN setting, press R or L to change the direction of the channel stick. Press UP or DN to navigate the STATUS, which can check the sketch map of the stick OPEN/CLOSE direction. Check if it was set correctly.

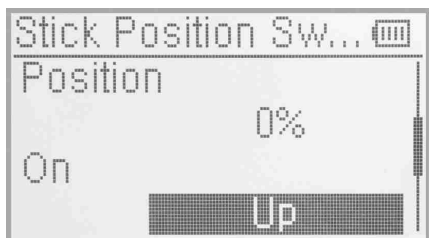

After finished the setting, press EXT to exit.

2.9 Device select

This setting can help you configure various functional switches, or adjust levers. It includes Flight Mode Switch, Stunt Trim Select, Throttle Hold Switch, Hover pitch select, Hover throttle select.

Press ENT to enter Main Menu, press UP or DN to move navigation mark to select Model menu. Press ENT to enter Model menu function. Press UP or DN to select Device Option. Press ENT to Device Option interface.



(1) Flight Mode Switch: Press UP or DN to move navigation mark to Flight Mode Switch and press R or L to select the desired switch. The factory default setting is FMODE switch.

(2) Stunt Trim Select: There are two modes: Common and Flight Mode. In Common Mode all the trim values, which various sticks are corresponding to, put equal effect on all the flight modes. In Flight Mode, the trim value,

each of which stick is corresponding to, puts independent effect on the corresponding stick. The factory default setting is Common.

Press UP or DN to choose the Stunt trim select, press R or L to select "Common" or Flight Mode, the factory default setting is Common.

(3) Throttle Hold Switch: Refer to "(1) Flight Mode switch"

(4) Hover pitch select: Refer to "(1) Flight Mode switch"

(5) Hover throttle select: Refer to "(1) Flight Mode switch"

After finishing the setting, press EXT to exit.

2.10 Device Output

Device output can set up the output switches respectively. It can also activate, inhibit or use other functions. There are eight items in total: FMODE switch, MIX switch, ELEV D/R switch, AILE D/R switch, RUDD D/R switch, GEAR switch, SPS0, SPS1, SPS2, SPS3, left trim, right trim, AUX4 knob, AUX5 knob.

Setting:

Press ENT to enter main menu, press UP or DN to move navigation mark to Model Menu. Press ENT to enter Model Menu. Press UP or DN to select Output Device and press ENT to enter Output Device interface.

There are 5 settings: Gear, AUX2, AUX3, AUX4, AUX5.

(1) Gear

Press UP or DN in output interface can change the gear switch. It includes FMODE, MIX, ELEV D/R, AILE D/R, RUDD D/R, GEAR, SPS0, SPS1, SPS2, SPS3, Left trim, Right trim, AUX4 knob, AUX5 knob. Press R or L to select the setting switch, The default setting is GEAR SW.

Press UP or DN to select Function Setting after you select the switch, Press R or L can enter the interface of Gear activate, inhibit and Governor. The default setting is Activate. You can continue to set other items after finishing.

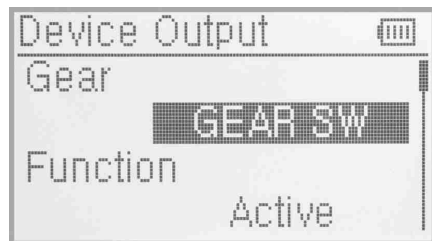

(2) AUX 2

Press UP or DN to enter the AUX2 interface. Press R or L can change the AUX2 switch. It includes FMODE, MIX, ELEV D/R, AILE D/R, RUDD D/R, GEAR, SPS0, SPS1, SPS2, SPS3, Left trim, Right trim, AUX4 knob, AUX5 knob. The default setting is FMODE switch.

Press UP or DN to select the Function Setting, press R or L to choose the switch, it includes Inhibit, Activate, Gyro, Governor, the default setting is Gyro. You can continue to set others items after finishing .



(3) AUX3

Press UP or DN to enter AUX3 interface. Press R or L can change the AUX3 switch. It includes RUDD D/R,GEAR,SPS0,SPS1,SPS2,SPS3,Left trim,Right trim,AUX4 knob,AUX5 knob. The default setting is RUDD D/R switch.

Press UP or DN to move navigation mark to Funtion Setting. Press R or L to desired item.The optional items are Inhibit, Active, Gyro and Governor. The factory default is Active. Continue to set up other items after setting finished.



(5) AUX4,AUX5 settings please refers to AUX3 settings. AUX4 default setting is AUX4 knob, AUX5 default setting is AUX5 knob.

After finishing the setting, press EXT to exit.

2.11 Swash Type

The swash type is grouped into five options: 1 Servo Normal, 2 Servos 180°, 3 Servos 120°,3 Servos 140°, 3 Servos 90° and 4 Servos 90°.

Press "ENT" to enter Main Menu, press UP or DN until "MODEL" flash , and then press "ENT" to enter Model Menu; Press UP or DN to choose"SWASH"press ENT enter to Swash setting interface.



Press UP or DN to choose the required swashplate type. Press ENT to confirm, the corresponding items will have the"✓"mark in front of the items.Press EXT to exit after finishing.

2.12 Power Amplifier

The transmission output power of DEVO-10 is adjustable. It is divided into six grades from small to big. The lower the transmission output power transmits, the shorter the radio range is, and the longer the stand-by time will be, the higher the transmission output power, the farer the radio range, and the shorter the stand-by time. Choose the appropriate transmission output power according to the actual situation.

Press ENT to enter the Main Menu. Press UP or DN to choose "Model Menu"and then press ENT to enter the interface. Press UP or DN to choose the appropriate output power , press ENT to confirm.

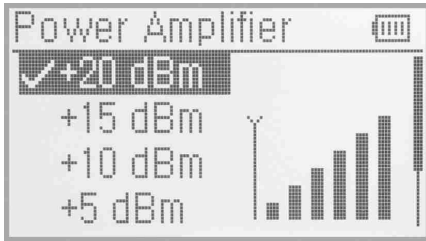

Press UP or DN to choose the required AMPLI. Press ENT to confirm then the corresponding items will have "✓"mark in front of the items.The AMPLI rate will be shown on the interface.

After the setting, press EXT to exit.

2.13 Fixed ID

This setting will bind DEVO-10 with its receiver in a unique corresponding relationship. It will greatly speed up the time of automatic binding when DEVO-10 power on.

(1) Setting for fixed ID

The setting for fixed ID should be under the status that automatic ID binding is successfully finished. Below is the setting method.

Press ENT to enter the Main Menu and push UP or DN to move the navigational mark to select Model Menu. Press ENT to enter Model Menu. Press UP or DN to select Fixed ID and press ENT to enter the Fixed ID setting interface.

If you want to activate the fixed ID setting, press R or L to change the status from off to on. A series of random digits will be shown below after changing to on.

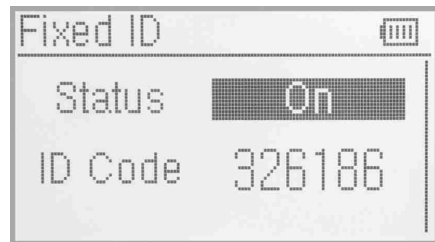

Press UP or DN to choose the ID code setting, press R or L to choose the words or number, press UP or DN moves to the next code setting, there are 6 words can be set to ID code.



Press ENT after the new ID has been set. An inquiry interface of "Are you sure?" pop up. "ID Code Matching" will be shown after press ENT. After matching, the interface will be returned to Model Menu.

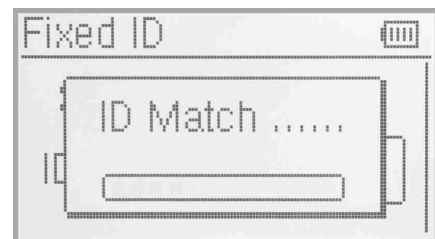

(2) Fixed ID cancellation

Insert the assorted BIND PLUG into the output terminal of BATT before the receiver power on, and then plug 5V DC power into other output terminal. The red light of receiver will flash slowly. This means the fixed ID code has been cancelled. Pull out bind plug. DEVO-10 also need to make relative cancellation and revision after the fixed ID in receiver is cleared out.

In the main interface press the ENT to enter Model Menu and then press UP or DN to move the navigational mark to select Model Menu. Press ENT to enter Model Menu. Press UP or DN to select Fixed ID code and push ENT to enter the Fixed ID code interface. Press UP or DN to select STATUS option, Press R or L to change the status to off. Then press EXT to exit.



2.14 Sensor setting

Setting method: press ENT enter to the Main Menu. Press UP or DN to select the Model Menu. Press ENT enter to Model Menu. Press UP or DN to select sensor press ENT enter to the sensor setting interface. See the Illustration.



Press R or L to select Activate or Inhibit (the default setting is Inhibit), such as press Activate will includes No Signal Warning, Voltage sensor, Temperature sensor, GPS receiver setting etc.

(1) No Signal Warning

Press UP or DN to make the navigation mark to choose "No Signal Warning". Press R or L to choose "Inhibit" or "Active" (default setting is "inhibit"). If you choose "Active", the Radio will alarm when telemetry signal lost. As following:



(2) Voltage setting

There are 3 different types of voltage can be measured. It includes Internal 5V, External V1 and V2 which can be monitored two different external voltage (i.e. battery) respectively. Once the measured voltage is lower than the setting value, the Radio will alarm.

(2.1) Receiver 5V (Internal) PFV (Power Feeding Voltage) Alarmed value can be set as 3.6-6V

Voltage setting: press R or L to activate the 5V, the alarm interface will appear in the interface, please refer to the Illustration.



Press UP or DN to select the Alarm Voltage setting, press R or L to set the value. The range is 3.6-6V. you can continue to set other items after you finished.

(2.2) External V1

Press UP or DN enter to External V1 setting interface. Press R or L to activate the V1,the details refers to the Illustration.



Press UP or DN to select the Alarm Voltage setting. Press R or L to set the value. The setting range is 0.2~99.9V. you can continue to set other items after you finished.

(2.3) External: V2 setting can refer to External V1 setting.

Press EXT back to sensor setting interface after you finished.

(3) Temperature sensor

The temperature sensor can measure up to 4 different temperature(i.e.motors).You can choose Celsius or Fahrenheit.The alarmed value can be setted to 4 different temperature.Once the measured value is higher than the setting value,the radio will alarm.The Alarm Temperature value can be setted as -20~220°C or -4.0~428.0° F.

Temperature Setting:

In the "Sensor Setting"interface,press UP or DN to make the navigation mark to choose "Temperature Sensor",and press ENT to enter "Temperature Sensor"setting interface. See the illustration.



(3.1) Unit

Press UP or DN to make the navigation mark to choose "Unit"setting item,and press R or L to choose Unit, two kinds of Unit:Celsius and Fahrenheit.

(3.2) Alarm Temperature settings

Press UP or DN select the T1 ,Press R or L to activate the setting.Inhibit will change to Active and Alarm temperature will be shown. If you choose Inhibit, the Alarm temperature value won't be shown.

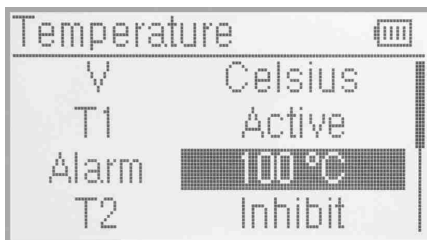

Press UP or DN to select "Alarm"setting,press R or L to set the alarm temperature value.Press UP or DN to set other items after finishing the setting.

(3.3) T2,T3,T4 setting

Refer to the step of "(3.2)T1".

(4) GPS setting

There are 4 items including Altitude Type,Speed Unit,Date Type and Time Zone in the GPS receiver setting interface.

Press UP or DN to select the Sensor setting interface to enter the GPS setting interface.

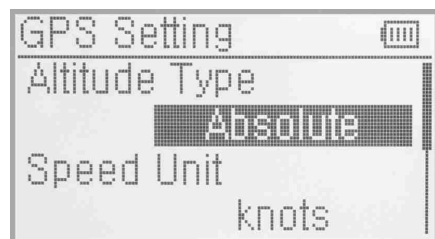

(4.1) Altitude Type

Press UP or DN to select the Altitude type on the GPS setting interface and it's Absolute and Relative.

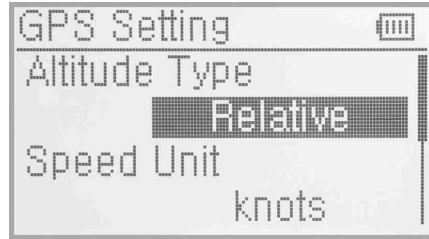

(4.2) Speed Unit

Press UP or DN to select the Speed Unit on the GPS setting interface and it includes knots and km/h and relative. Select the desired item.



(4.3) Date Type

Press UP or DN to select the Date Type on the GPS setting interface and it includes DD-MM-YY,MM-DD-YY and YY-MM-DD. Select the desired item.

(4.4) Time Zone

Press UP or DN to select the Time Zone , press R or L to set the desired Time Zone.



(4.3) Date Type



(4.4) Time Zone

3.0 Function Menu

Function Menu can help you custom adjustments for the selected models. The menu include items such as Reverse Switch, Travel Adjust, Sub Trim, Dual Rate and Exponential, Throttle Hold, Throttle Curve, Mix to Throttle,Gyro Sensor, Governor,Tail Curve, Swash Mix,Pitch Curve, Program Mix, Monitor,Fail Safe, Sensor view, Trainer and Timer.

3.1 Reverse Switch

Press ENT in main interface to enter Main Menu; Press UP or DN to move the navigation mark to Function Menu. And press ENT to enter Function Menu, Press UP or DN to choose Reverse Switch and Press ENT to enter into Reverse Switch interface.

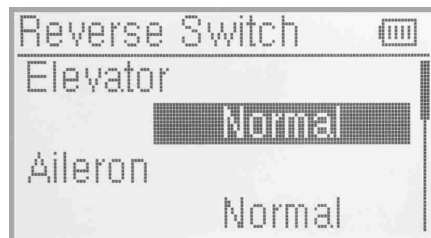

Press UP or DN to move navigation mark to ELE(take Elevator for example), Press R or L to shift the status between normal and reverse. These are two status for option. And the default setting is Normal. All Channels Reverse Switch like: Aileron, Throttle, Rudder, Gear, Pitch, Aux2, Aux3, Aux4 and Aux5 can be referred to the way of ELEV Reverse Switch. And press EXT to exit after finishing setting.

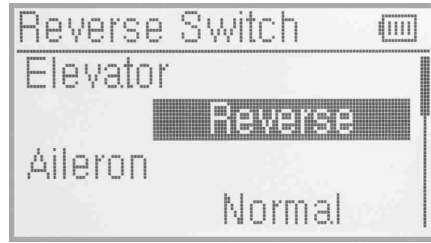

3.2 Travel Adjust

Press ENT to enter into Main Menu. Press UP or DN to move navigation mark to select item Function Menu. Press ENT to enter Function Menu. Press UP or DN to select Travel Ajust, Press ENT to enter Travel Adjust interface, as below illustration. It shows the Travel Adjust status of one channel:



Take ELEV for example, Press UP or DN to move navigation to desired item Elevation of U. Press R or L to decrease or increase the servo travel range. The adjustment range is from 0.0% to 150.0%. The factory default is 100.0%.

Press UP or DN to move navigation mark to desired item D of ELEV. Press R or L to increase or decrease the servo travel range. The range is from 0.0% to 150.0%. The factory default is 100.0%.

All other channel's Travel Adjust like Aileron, Throttle, Rudder, Gear, Pitch, Aux2, Aux3, Aux4 and Aux5 can be referred to ELEV travel Ajust. Press EXT to exit after setting finished.

3.3 Sub Trim

Sub Trim can move the neutral point of the servo. But we advise you to mechanically adjust the servo bell crank if offset is far away from the neutral point of servo, because excessive usage of the sub trim may damage the servo.

Setting method:

Press ENT to enter Main Menu, Press UP or DN to move the navigation mark to desired item Function Menu. Press ENT to enter Function Menu, Press UP or DN to select Sub trim, and press ENT to enter Sub Trim interface.



The interface show the items and the channels which are adjustable. Press R or L to change the neutral point of Servos. The factory default is 0.0%. Press UP or DN to choose desired items. The range as below:

Channel name	Adjustment range	Channel name	Adjustment range
Elevator	D62.5% ~ U62.5%	Pitch	L62.5% ~ H62.5%
Aileron	R62.5% ~ L62.5%	AUX2	-62.5% ~ +62.5%
Throttle	L62.5% ~ H62.5%	AUX3	-62.5% ~ +62.5%
Rudder	R62.5% ~ L62.5%	AUX4	-62.5% ~ +62.5%
Gear	-62.5% ~ +62.5%	AUX5	-62.5% ~ +62.5%

Press EXT to exit after adjustment finished.

3.4 Dual rate and Exponential

It is possible to use D/R switch to control over the dual rate of elevator, aileron, and rudder after the function of Dual Rate and Exponential is set up. The setting range is 0-125%. Under the help with exponential curve adjustment, it is not only manually but also automatically able to set up various parameters which are suitable for yourself.

Setting method

Press ENT to enter Main Menu. Press UP or DN to move navigation mark to desired item Function Menu. Press ENT to enter Function Menu, press UP or DN to choose Dual rate and Exponential, Press ENT to enter D/R and Exponential interface.

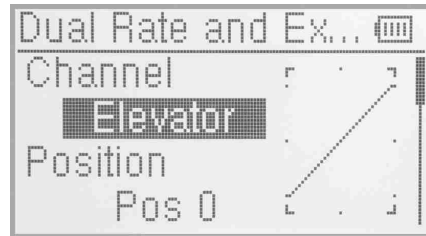

(1) Channel selection

Press UP or DN to move navigation mark of Channel, Press R or L to set up channels containing Elevator, Aileron and Rudder. Choose the desired channel for setting.

(2) Position selection

Press UP or DN to move navigation mark to desired item Position. In the manual mode, the function of Dual rate and Exponential will be executed by the corresponding D/R switch among Pos0 and Pos1. Take the item Elevator at channel as an example. It's possible to shift between Pos0 and Pos1 via pushing or pulling the D/R switch.



(3) Dual rate adjustment

Press UP or DN to move the navigation mark to desired item Dual Rate. It's possible to change the dual rate value of Position via pressing R or L and the corresponding value curve in the right top of interface will be changed accordingly. The factory default is 100%.

(4) Exponential

Press UP or DN to select Exponential item of navigation mark. It's possible to change Dual Rate and Exponential value in Pos when pressing R or L to change the value. There are $\pm 100\%$ and Line three adjustment. At the same time, the corresponding curve will be changed and shown at the right graph.

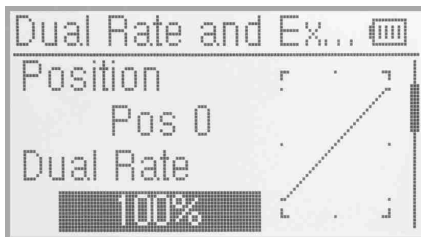

(3) Dual rate adjustment

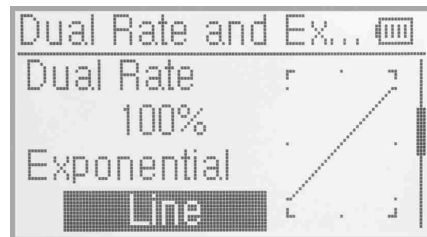

(4) Exponential

(5) Automatic setting

Under working with Flight Mode, it's possible to switch the dual rate and exponential, which are set in above(3) and (4) Exponential adjustment.



The setting for Normal Mode, Stunt1, Stunt2 and throttle hold are available. But Throttle Hold in Function Menu should be set as Active (refer to 3.5 Throttle Hold below).

(5.1) Normal Flight Mode setting: Press UP or DN in the navigation mark of Dual rate and Exponential to select the desired item Normal Flight. Press R or L to set the position and the Switch. Only the D/R switch control is valid When Switch is selected, under the Flight Mode, it's possible for Pos to switch the dual rate and exponential, which are set in above(3) and (4)Exponential adjustment. The settings for Swtich, Pos0, Pos1, Pos2 and Pos3 are valid.

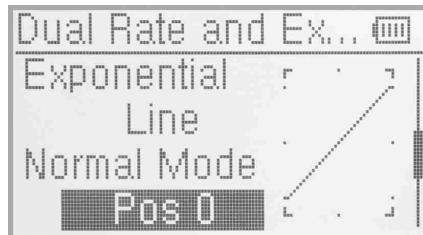

(5.2) The setting for Stunt1, Stunt2 and Throttle Hold can be set up according to above Normal Flight Setting. Press EXT to exit after finishing the setting.

3.5 Throttle Hold

If this function is set, the switch will be executed by hold switch. The setting value of throttle hold is ranged from -20.0-50.0%. the default setting is Inhibit.

Setting method:

Press ENT to enter Main Menu, Press UP or DN to move navigation mark to select Function Menu. Press ENT to enter Function Menu. Press UP or DN to select Throttle Hold, Press ENT to enter Throttle Hold interface, as below illustration:



Press R or L to activate Throttle Hold function, and expansion list will be shown as Throttle hold status, Throttle hold position and Throttle hold switch.

(1) There are two items under Throttle Hold Status: Active and Inhibit. The factory default setting is Inhibit.

(2) Throttle Hold position

In the Throttle Hold interface, press UP or DN to make the Navigation mark to choose "Throttle Hold Position" setting options. Press R or L to change data, the minimum value is -20.0%; the maximum value is +50.0%.

(3) Throttle Switch setting

It's invalid for setting, the factory default is RUDD D/R which will be shown in the status item. When the Throttle Hold switch is on, data under the Throttle Hold can not be amended until Throttle Hold switch to be off, and the hold status is changed.



Press EXT to exit after setting up finished.

3.6 Throttle Curve

Throttle curve are adjusted through seven points, which of all the flight modes can be respectively set. The flight mode include Normal Flight, Stunt1 and Stunt2.

Press ENT to enter main menu, Press UP or DN to move navigation mark to select Function Menu. Press ENT to enter Function Menu. Press UP or DN to select Throttle Curve, Press ENT to enter Throttle Curve interface. The enquiry dropdown is shown "All servos hold?" If click OK, all the servos will be locked at the current status, if click Cancel, all the servos will be unlocked at the current status.

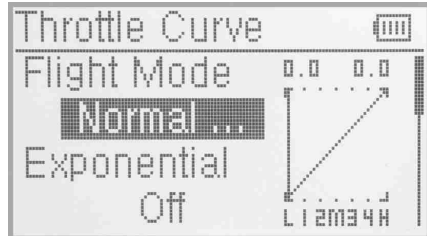
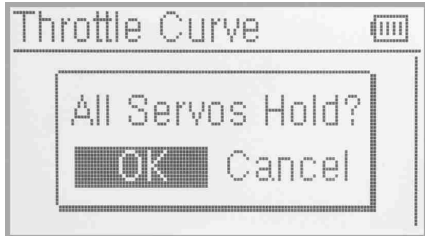

(1) Flight Mode

There are total three flight modes: Normal Flight, Stunt1 and Stunt2. The Curve of which can be respectively set in their corresponding flight mode. The setting method is to press UP or DN to select Flight Mode in Throttle Curve interface. The corresponding flight mode will be shown when the Flight Mode switch shifts via pushing or pulling the Flight Mode Switch. And the exponential can be adjusted after Flight Mode is selected.

(2) Exponential Adjustment

Press UP or DN in Throttle Curve interface to move navigation mark of exponential curve and press R or L to set the exponential function Off and On. The throttle curve will be changed smoothly if touching ON, or in fold line if clicking OFF.

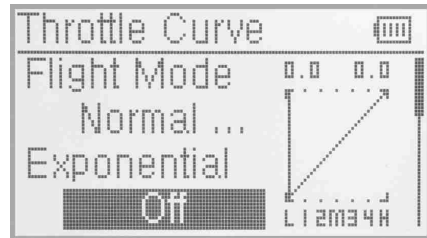

(3) Curve setting

It includes two items: Point and Output.

(3.1) Adjustment for Point

Press UP or DN in Throttle Curve interface to move the navigation mark to desired item Point. Press L, an expansion list including "-L" "-1", "-2", "-M", "-3", "-4" and "-H" seven points is shown and can be selected via pressing R or L.

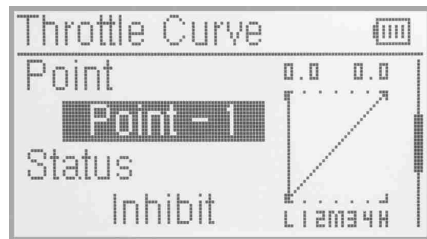
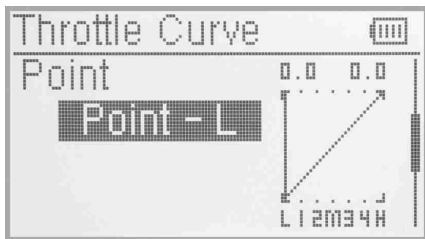

(3.2) Status adjustment

Press UP or DN to move navigation mark to Status and press R or L to choose Inhibit or Activate. Click Inhibit if you don't amend the amount of the selected point. The factory default is Inhibit. Click activate if you want to amend the amount of the selected point.

(3.3) Output adjustment

An expansion list of Output and Hover items will be shown after activating the Status. Press UP or DN to move navigation mark to select Output item. And press R or L to increase or decrease the amount of selected point with a minimum of 0.0% and a maximum of 100.0%.

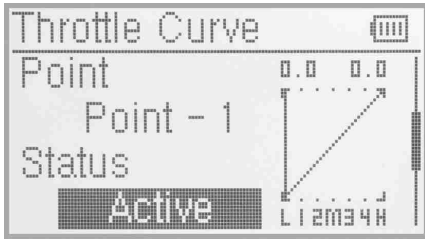

(3.2) Status adjustment

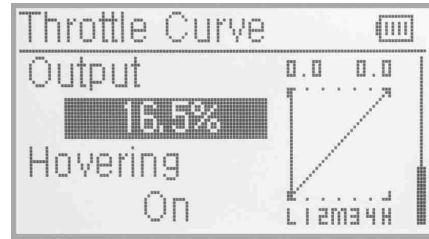

(3.3) Output adjustment

(3.4) Hovering Adjustment

After the setting of (3.3) Output adjustment is finished, it's necessary to set the item of Hovering as On and all the selected points of the throttle curve should be activated if using throttle trim in flight is a must. The five points of 1-2,M,3-4 in the curve will be paralleled or down with the changing of throttle trim. So the throttle curve will be paralleled up or down with the movement of the five points.

Press EXT to exit after finish the setting.

3.7 Mix to throttle

This Function can keep the main rotor blades running at the certain revolution caused by the changed load when operation the aileron servo, elevator servo and rudder servo. Generally, it's not advised to use the function.

Setting method:

Press ENT to enter Main menu in the main interface. Press UP or DN to move navigation mark to select Function Menu. Press ENT to enter function menu. Press UP or DN to select Mix to Throttle. And press ENT to enter Mix to throttle interface as in below illustration.

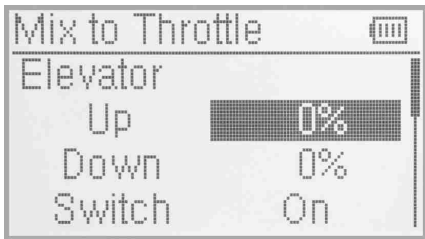

There are three settings: elevator, aileron and rudder. If the item of Channel is shown as Elevator, there are UP, DOWN and Switch in the interface. If the item of Channel is Aileron or Rudder, the contents in the said interface will be changed into Left, Right and Switch. Take the example of Channel set as Elevator to illustrate the setting method.

(1) Up setting

In the Mix to throttle interface, press UP or DN to move the navigation mark to select UP item. Press R or L to increase or decrease the mix amount when moving the throttle stick upwards. The bigger the amount is, the bigger the mix to throttle will be. Change the amount from "+" to "-" for the throttle mix direction Reversing. The adjustable range is ±125%.

(2) Down setting

In the interface of Mix to Throttle, press UP or DN to move the navigation mark to select Down item. Press R or L to increase or decrease, respectively, the mix amount when moving the throttle stick downwards. The bigger the amount is, the bigger the mix to throttle will become. Change the amount from "+" to "-" for the throttle mix direction Reversing. The adjustable range is ±125%.

(3) Switch Selection

In the interface of Mix to Throttle, press UP or DN to move navigation mark to select Switch item. Press R or L, an expansion list of Always on, Normal Mode, Stunt1, Stunt2 and Gear is shown. After setting finished, Aileron or Rudder can be set via pressing DN.

(4) The setting of Aileron or Rudder, and Mix to Throttle can be referred to Elevator setting. Press EXT after setting finished.

Note:

- (1) Before the flight, please confirm: All above amount of mix to throttle is proper enough to offer a good flight. And make sure all the actions in different flight mode are normal.
- (2) The function is in spare when governor is working.

3.8 Gyro Sensor

This function supply the GYRO sensitivity adjustment,both through switch 'D/R' to Manual and "Flight Mode"Automatic switch different sensitivity.

Setting method:

Press "ENT" into "Main Menu" in the interface;press "UP/DN" to choose "functional menu".Press "ENT" into "functional menu";press "UP/DN" to choose "Gyro Sensor", then press "ENT" into "Gyro Sensor" interface.



(1) Manual Setting

(1.1) Manual Setting

In the Gyro Sensor interface,press UP/DN to choose "mode"project set,press R/L to selectable set ("Manual set" and "Automatic set").Then choose "Manual" option.

(1.2) Channel

The original channel is "AUX2",if you want to change to other channels control,you can choose from "Output"set.(refer to "2.1 Output").

(1.3) Switch choose

In the Gyro Sensor interface,press UP/DN to choose "SWITCH "project set,press R/L to selectable sets "FMOD SW",MIX SW,ELEV D/R,AILE D/R,RUDD D/R,GEAR SW ,totally 6 selectable sets.Choose the Manual control switch.

(1.4) Sensitivity Setting

If choose 3 switches,there are "position 0","position 1" and "position 2",then set the sensitivity individually;If choose 2 switches,there are "position 0" and "position 1",then set the sensitivity individually.

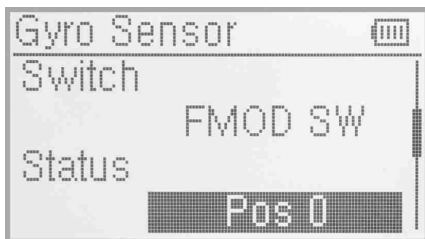

(1.4.1) position 0

Turn the choosed GYRO Control Switch,make the status display present switch status "position 0".Press UP/DN to choose "position 0",press R/L to increase/decrease value individually.If the GYRO have "NOR"mode and "AVCS" mode,when the value lower than 50%,it is "NOR"mode,the lower of the value is ,the bigger of the GYRO sensitivity becomes. The factory default value is 50%.

(1.4.2) "Position 1"," Position 2" are the same setting way as above "position 0".

(2) Automatic setting

(2.1) Automatic Setting

In the Gyro Sensor interface,press UP/DN to choose "mode"project set,press R/L to selectable sets ("Manual set" and "Automatic set").Then choose "Automatic" option.



(2.2) Channel

The original channel is "AUX2",if you want to change to other channels control,you can choose from "output"set.(refer to "2.11 output").

(2.3) Switch:there is no use in the Automatic Setting.

(2.4) Status

Turn the Switch "flight mode"or "Throttle hold",the status set display present flight mode position.There are "Normal Mode","Stunt 1","Stunt 2","Throttle hold" sets. "Throttle hold" need to start that can effect.(refer to "3.5 throttle hold")

(2.4.1) Normal Mode

Press UP/DN to choose "Normal Mode" project set, press R/L can increase or decrease the value individually. If the GYRO have "NOR" mode and "AVCS" mode, when the value is lower than 50%, it is "NOR" mode. the lower of the value is, the bigger of the GYRO sensitivity becomes. The factory default value is 50%.

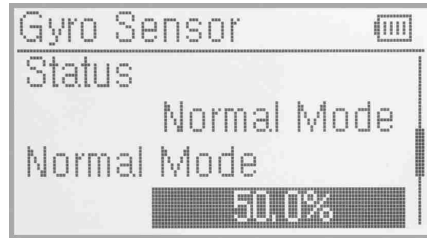

(2.4.2) "Stunt 1", "Stunt 2", "throttle hold" settings refer to "Normal Mode".

After finishing the set, press EXT to exit.

3.9 Governor

Before setup this function, "Governor" should be set and activated in "output" interface. (Refer to 2.10 Output) It is possible to set Governor control rate in various flight modes separately. Please setup the Governor for the desired rotation speed. The transmitter display data is only for percentage reference. The real rotation speed refer to Governor.

Setting method:

Press "ENT" to the "Main menu" in the interface; Press "UP/DN" to make the navigation bar choose "functional menu". Press "ENT" to "functional menu"; Press UP/DN to choose "Governor" then through the 'ENT' key to the Governor setting interface, which display the status and channels; Press UP/DN can see the "Normal Mode", "ST1", "ST2", "Throttle Hold" and so on.



(1) Status

Toggle the Flight Mode or Thottle Stick Lock switch, the status display present flight mode position. There are "Normal Mode", "ST1", "ST2", "Throttle Hold" and so on. "Throttle hold" need to start that can effect. (refer to "3.5 throttle hold")

(2) Channel: displaying in "2.10 output" have set the Channel. (refer to 2.10 Output)

(3) Normal Mode

Press "UP/DN" to make the navigation choose the "Normal Mode" set, press R/L to increase/decrease the value. The factory default value is 0%.

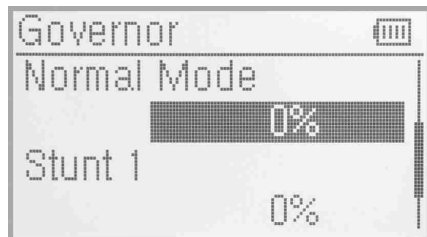

(4) The method to set "ST1", "ST2", "Throttle Hold" refer to "Normal Mode".

After the set finished, press EXT to exit.

3.10 Tail Curve

This function is mainly used for amending the reaction torque produced by pitch angle of main rotor blades. In the set flight mode, the mix amount can be automatically switched when moving the flight mode (FMOD) lever. Press "ENT" to enter the "main menu"; Press "UP/DN" to make the navigation mark to choose the "functional menu"; Press UP/DN to choose "Tail Curve", then press "ENT", there will be shown an enquiry of "all Servo hold?". Click ok for locking the current status of all the Servos, and cancel for unlocking the current status of all the Servos; After finish the choose, press ENT to "Tail Curve" interface. There are current flight status, curve graph and adjustable items.

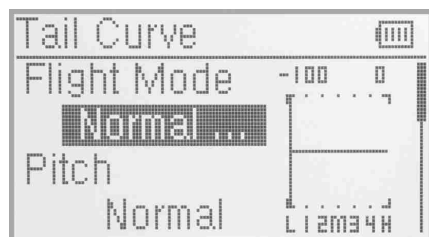
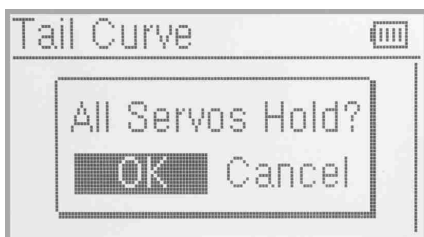

(1) Flight Mode

In the "Tail Curve" interface,press UP/DN to make the navigating mark choose "Flight Mode" set .Toggle the flight mode switch and shown the current flight mode.In the set of flight mode can set "pitch","exponential curve","curve point setting",and "output "items.

(2) pitch

Press UP/DN to make the navigation mark choose "pitch" set,press R/L to choose the two options Normal and Original.Select the desired item.

(3) Exponential Curve

Press UP/DN to make the navigation mark choose "Exponential Curve"set, press R/L to choose two options ON and OFF.The curve will be smoothly changed if touching on.Select the desired item.

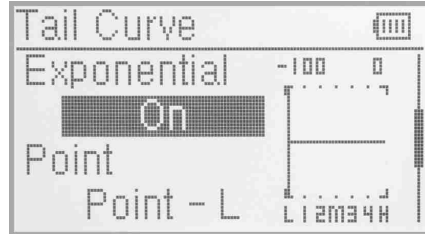

(4) Curve Point Setting

Press UP/DN to make the navigation mark choose "Curve Point" set.

(4.1) Point Selection

Press R/L to set the Curve Point options "point-L","point-one","point-2","point-M","point-3","point-4","point-H" ,totally seven options;Select the point which you want to adjust.

(4.2) Statues Setting

Press UP or DN option to choose the State setting after adjusting the date point.Press R or L keys,there are two options of "inhibit" or "active"(Choose "point-L" or "point -H",there is no state menu that will be shown).If you don't want to change the date,then choose "inhibit"(default setting is "inhibit").If you want to change the date,then choose "active", "Output " item will be expanded.

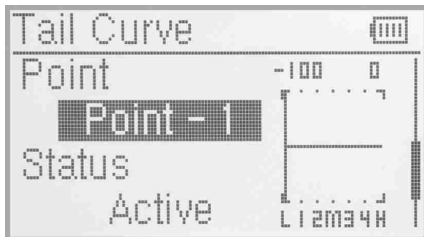

(4.1) Point Selection

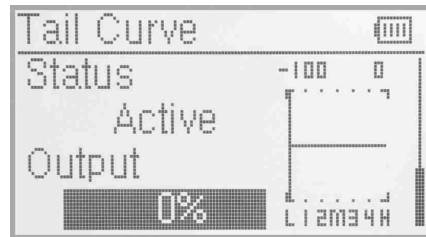

(4.2) Status Setting

(4.3) Output Setting

Press UP/DN to make the navigation mark choose"output" set,press R to increase point's output;the minimum amount is +100%;press L to decrease point' output amount;the maximun amount is -100%.

(4.4) The methods to set "ST1","ST2", "Throttle Hold" refer to "Normal Mode".after finished ,press EXT to exit.

Notes: If an AVCS Gyro is used,this function is not necessary.

3.11 Swash Mix

This function, which can be executed through flight mode, is used for amending the variation caused by swashplate movement, when the aileron or elevator is working.

Press the “ENT” to enter Main Menu and then press UP or DN to choose the navigation mark of enter Function Menu. The interface will show the Swash Mix Setting after press the “ENT” . The “Swash Mix” item is only effected after choose the two or more servos in “2.11 Swash Type”.Take the third servo 120° as an example.



(1) Swash Type

The item will show the current swash type if choose the two or more servos in “2.11 Swash Type”,the choosed swash type is the third servo 120° .

(2) Aileron Mix Adjustment

In the interface of Swash Mix,press UP or DN to choose the navigation mark of Aileron Setting item. Press R button to increase the rate and L to reduce. If reversed direction, it is available to chang through the “+” or “-” mark. The adjustable rate is ±125%. After finish the settings,press DN to set others.

(3) Elevator mix adjustment

The function is based on the three or more servos which is choosed(refer to the 2.11 Swash Type).The setting method is same as above.

(4) Pitch Mix Adjustment

The function is based on the two or more servos which is choosed(refer to the 2.11 Swash Type).The setting method is same as above.



(5) Exponential Curve

This function can execute the exponential changes, which are set at Dual Rate and Exponential in Function Menu when it is started. If Off is selected, the exponential curve will be changed in the form of fold line.



Setting method:

Press UP or DN to touch the navigation mark of Exponential to expand two options: Off and On, the default setting is Off. On is recommended.

Please press EXT key to exit after finished.

3.12 Pitch Curve

Pitch curves are adjusted through 7 points, which of all the flight modes can be respectively set. There are “Normal Mode”, “Stunt 1”, “Stunt 2”and “Throttle hold” 4 flight modes.

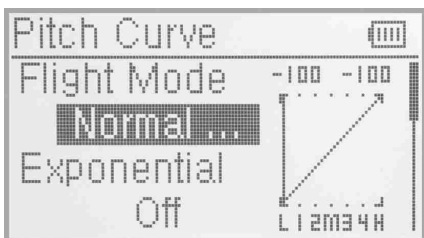

Setting method:

Press ENT to flash main menu. Press UP or DN key, function will flash and then press ENT to enter function menu. Press UP or DN, “PTCRV” will flash, a dropdown pops up “All servos hold?”to enter the interface of servo hold . Click OK for all the servos will be locked at the current states.Click Cancel for Unlocked.Enter the next interface after clicking OK or Cancel.

(1) Flight mode

Press UP or DN to enter the Flight Mode at the interface of Pitch Curve, and then move the switch of flight mode, the state of flight mode will be shown. The Pitch Curve can be set at the current state. There are "Normal Mode", "Stunt 1", "Stunt 2" and "throttle hold" 4 flight modes. The "Normal Mode" is made as an example for your reference.

(2) The Setting of Pitch Curve

Press UP or DN to choose the setting item of Pitch Curve. There are ON or OFF option when you press the R or L buttons. The Curve Pitch will become round if the ON button is chosen. If you don't adjust the Pitch Curve Function, then choose OFF button.

(3) Setting of Curve Point

Press UP or DN to enter the setting interface of Curve Point. Press R or L keys of setting curve point, there are "point-L", "point -1", "point -2", "point -M", "point -3", "point -4", "point -H". Choose the points need adjusting.

(4) State Setting

Press UP or DN option to choose the State setting after adjusting the date point. Press R or L keys, there are two options of "inhibit" or "active" (Choose "point-L" or "point -H", there is no state menu that will be shown). If you don't want to change the date, then choose "inhibit" (default setting is "inhibit"). If you want to change the date, then choose "active", "Output" item will be expanded.

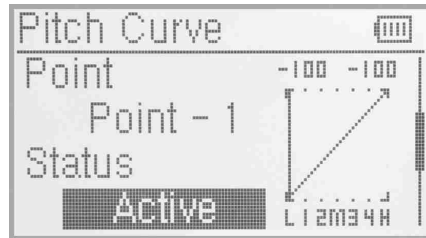

(5) Output Setting

Press UP/DN to make the navigation mark choose "output" set, press R to increase point's output; the minimum amount is +100%; press L to decrease point' output amount; the maximum amount is -100%.

(6) Hovering Setting

When the above setup finished, the item Hovering should be set as ON and each point of Pitch Curve should be activated at the same time if the PIT Trim needs to be adjusted in flight. The points of 1-2, M, 3-4 will move at the same level with the up and down of the PIT when adjusting the Hovering Trim.

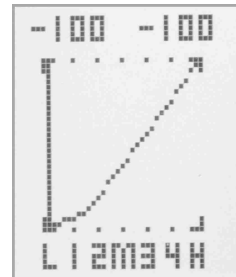
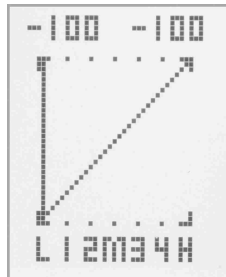
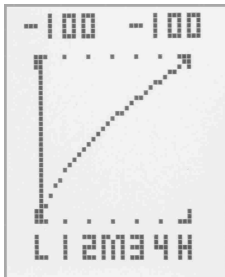

(7) There are "Normal Mode", "Stunt 1", "Stunt 2" and "Throttle hold" 4 flight modes. The PIT Curve can be set respectively at different models, the method of setting is as above. Press "EXT" key to exit after finished.

The basic examples are only for your reference. Adjustment to the real flights is a must.

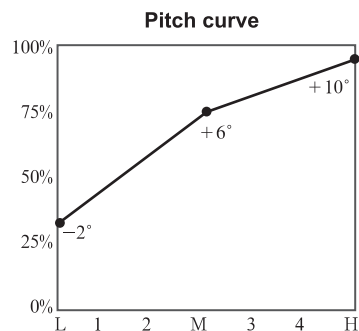
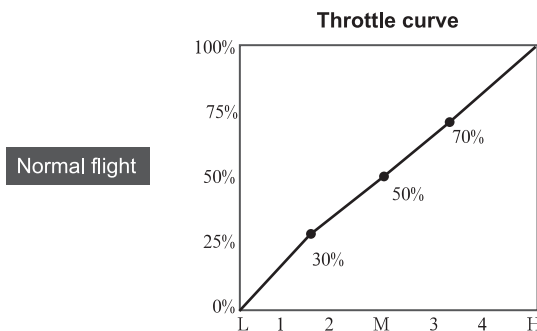

Flight mode 1

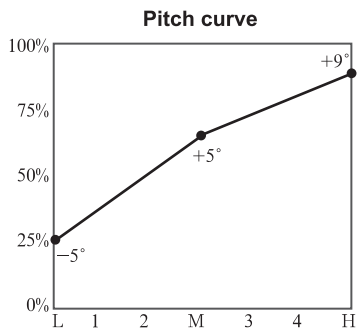
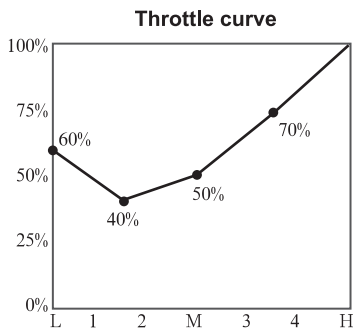

Flight mode 2

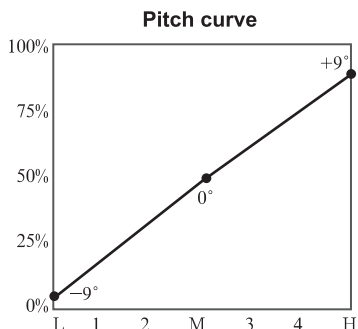
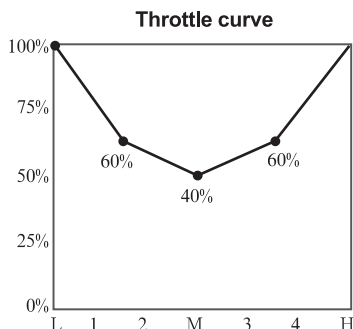

Autorotation landing

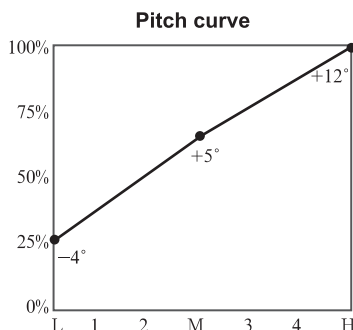

3.13 Program Mix

There are 8 series of program mix, mix channels and values are adjustable.

Setting Method:

Press ENT enter to main menu. Press UP or DN, FUNCTION is flashing, press ENT to enter function menu, then press UP or DN select "PRGMX". And press ENT to program mix setting and current status (default setting is "inhibit") interface. Press R or L to choose inhibited, normal or curve.

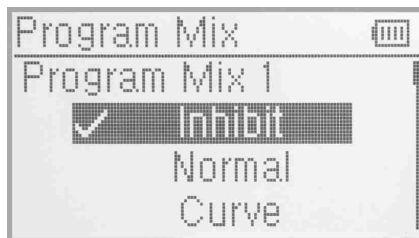

Take "program mix 1" for example, there are "normal" and "curve" setting.

(1) The "normal" setting of "program mix"

Press UP or DN select the "Normal" setting, Press ENT button then pop up "All Servos Hold?" Press R or L to choose OK or Cancel. If "OK" selected, all the servos will be locked in the current status, if "Cancel" selected, all servos are unlocked. Press ENT enter to Program mix setting interface.



(1.1) Master channel setting

Press UP or DN to move the navigational mark to select Master option and press ENT to Master interface. Pressing UP or DN to select the desired channel and press ENT to make a “√”. Press EXT to be back to Program Mix 1 interface.

(2) Slave channel setting

Press UP or DN to move the navigational mark to select Slave option and press ENT to Slave interface. Pressing UP or DN to select the desired channel and press ENT to make a “√”. Press EXT to be back to Program Mix1 interface.



(1.1) Master channel setting



(2) Slave channel setting

(1.3) Gain setting

Take Elevator at Master as an example.

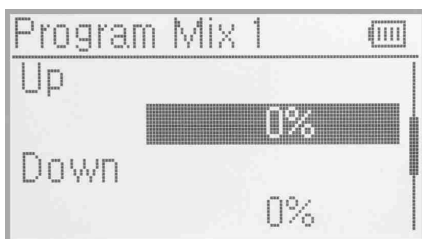

(1.3.1) UP:

Mix amount setting when elevator stick moved upward.

Press UP or DN to move the navigational mark to select Up to item. Press R or L to increase or decrease, separately, the mix amount. It is possible to reverse mix direction through changing the plus or minus sign before amount. The adjustable range is ±125%.

(1.3.2) Down:

Mix amount setting when elevator stick moved backward. Press UP or DN to move the navigational mark to select Down item. Press R or L to increase or decrease, separately, the mix amount. It is possible to reverse mix direction through changing the plus or minus sign before amount. The adjustable range is ±125%.

(1.3.3) Offset Setting

This function can make Slave begin to mix through the corresponding Lever switch from a certain point as the starting point.

Press UP or DN select the “Offset” setting, Press R to increase the mix amount and press L to decrease. It is possible to reverse Offset direction by pressing R or L button to change the plus or minus sign before amount. The adjustable range is ±100%.

(4) Switch Selection

Press UP or DN to choose the navigation mark of Switch setting item and press ENT to enter the select interface of Switch. It is chosen if the Switch item is marked with "√". There are "Normal Mode", "Stunt 1", "Stunt 2", "Throttle hold", ELEV D/R,AILE D/R,RUDD D/R and GEAR which can be chosen.

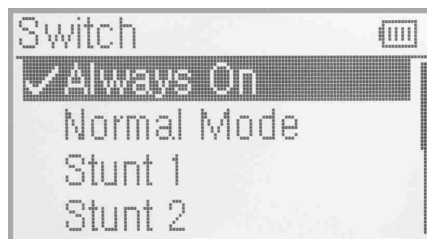

(2) Setting Method for Curve in Program Mix1

Press the item Curve in Program Mix 1 and expands an enquiry "All Servos Hold?" Click OK for all the servos will be locked at the current states; click Cancel for unlocked. Enter the next interface after clicking. Press ENT key to enter the setting interface of Program Mix1.The interface will show the setting items and curve table.

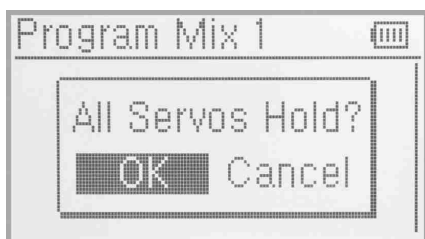

(1.1) Master channel setting

Press UP or DN to move the navigational mark to select Master option and press ENT to Master interface. Pressing UP or DN to select the desired channel and press ENT to make a "√". Press EXT to be back to Program Mix 1 interface.

(2) Slave channel setting

Press UP or DN to move the navigational mark to select Slave option and press ENT to Slave interface. Pressing UP or DN to select the desired channel and press ENT to make a "√". Press EXT to be back to Program Mix1 interface.

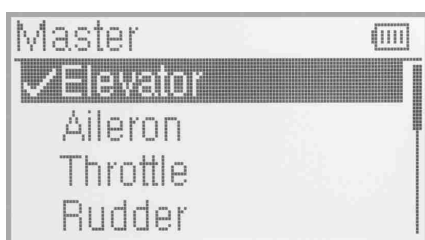

(2.1) Master Channel Setting

(2.2) Slave Channel Setting

(2.3) Exponential Curve

Press UP or DN to choose the setting item of Exponential Curve .There are ON or OFF option when you press the R or L buttons. The Curve Pitch will become round if the ON button is choosen.If you don't adjust the Pitch Curve Funtion, then choose OFF button.

(2.4) Point Setting

Press UP or DN to enter the setting interface of Point. Press R or L keys of setting point, there are "point-L", "point -1", "point -2", "point -M", "point -3", "point -4", "point -H". Choose the points need adjusting.

(2.5) State Setting

(There is no Status options when the piont is Point-L or Point-H) After selecting the point that you want to set, press UP or DN to move the navigational mark to Status item. Press R or L, there are two options of Inhibit and Active. Select Inhibit for unchanging the current amount (the default setting is Inhibit).

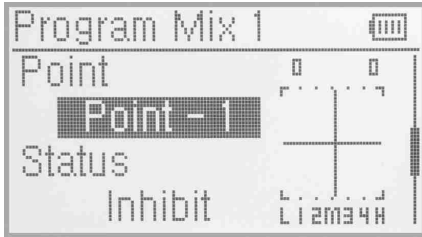

(2.4) Point Setting



(2.5) State Setting

(2.6) output setting

When the Status option is Active, the Output option will be listed. Press UP or DN to move the navigational mark to Output. Press R or L to increase or decrease, respectively, the output amount. It is possible to reverse the mix direction by changing the plus or minus sign before the amount. The adjustable range is $\pm 100\%$.

(2.7) Switch select

Press UP or DN to choose the navigation mark of Switch setting item and press ENT to enter the select interface of Switch. It is chosen if the Switch item is marked with "✓". There are "Normal Mode", "Stunt 1", "Stunt 2", "Throttle hold", "ELEV D/R", "AILE D/R", "RUDD D/R" and "GEAR" which can be chosen.

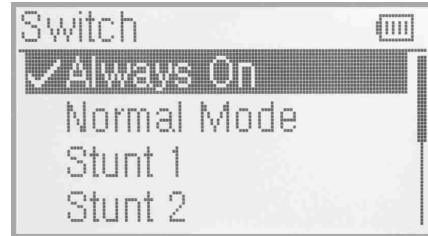

Press EXT key to return to the previous interface for other settings or press EXT key to exit after finished.

3.14 Monitor

This function can display the current status and positions of all the channels' outputs, and check the current working status of each channel.

Press ENT to enter Main Menu, and then press UP or DN to move the navigational mark to select Function Menu. Press ENT to enter the Function Menu and then press UP or DN to select servo Monitor and press ENT to enter the monitor interface for checking the current working status of each channel.

Press EXT to exit .

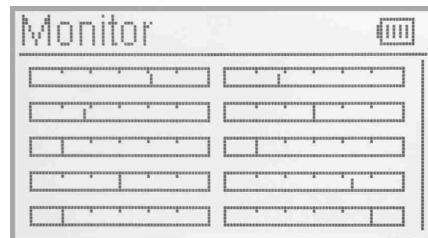

3.15 Fail safe

There are two possibilities for use if the transmission signal is under abnormal condition. The first one is to lock the last action data received; the second one is to execute the pre-set data which is pre-set. The default setting is Servo Hold.

Setting method:

Press ENT to enter the Main Menu, and then press UP or DN to move the navigational mark to select Function Menu. Press ENT to enter the Function Menu then press UP or DN to select Fail Safe and press ENT to enter the Fail Safe interface. Take the item Elevator as an example to explain.



Press UP or DN to select Elevator on the Fail Safe interface, then press R or L to change the status of Servo Hold into Fail Safe (If you want to keep Servo hold status, there is no need to re-set). There is an expanded sub-item below. Press UP or DN to select 0%, then press R or L to increase or decrease, respectively, the position amount which centers on the neutral point of servo. The available value is 125%, respectively. 0% is the neutral point of servo.



The setting methods for other channels are same as above. Press EXT to exit after finished.

Note: checking whether all the actions when fail safe happened are correct, is a must after the setting is finished. It is dangerous to use full throttle, especially after fail safe taken place.

3.16 Sensor View

Setting method: Press ENT to enter the Main Menu and press UP or DN to move the navigational mark to select Function Menu. Then press ENT to enter the Function Menu and press UP or DN to select Sensor View, then press ENT to enter the Sensor View interface, like below pictures. If all the sensors disconnect, telemetry signal lost, there will be inhibits shown on the view. If all work normal, all the measured data will be shown.

(1) Voltage: Show 3 different measured voltage value;

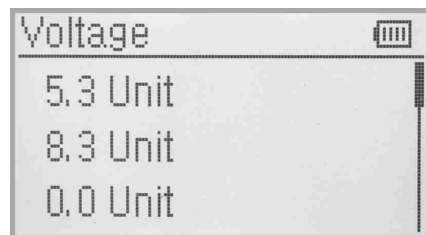

(2) Temperature: Show 4 different measured temperature value;

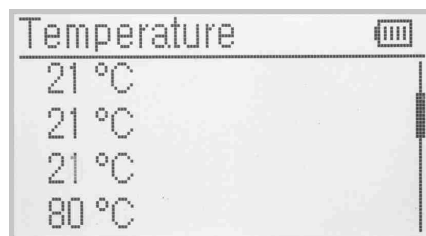
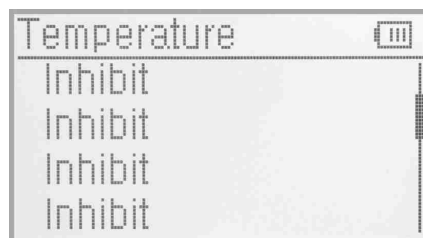

(3) Rate Sensor: Show 2 different measured RPM value;



(4) GPS Sensor: Press UP or DN to turn to GPS function, show located date, time, longitude, latitude, altitude and speed;

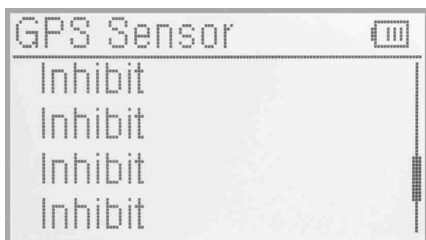

3.17 Trainer

Two DEVO-10 transmitters working together can execute the training function to meet the requirements for the beginner. The setting method is shown as below:

(1) Data copy

First, use the wireless copy function between two DEVO-10 to copy the main transmitter's model data to the trainee's transmitter, this promise the the model data between two transmitters is same. Refer the copy method to the second part of helicopter "2.4 model wireless copy" and do the following steps:

(2) Linkage

Insert the signal wire from the trainer's transmitter into the DSC socket of the trainee's transmitter. Turn on the transmitter and a linkage icon will be shown on the boot screen.

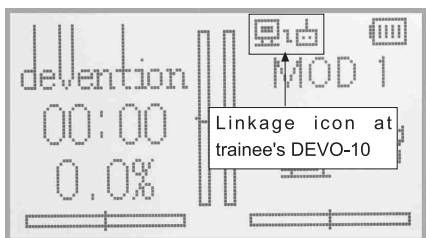

linkage icon

Turn on the power of the trainer's radio. Find out the trainee's model data, and then let the trainer's Radio bind with the aircraft model and fly it normally. Then turn off the power. Insert the other end of the digital signal wire into the trainer's DEVO-10, and then turn on its power. A linkage icon will be shown as below:



Trainee is off and trainer is working

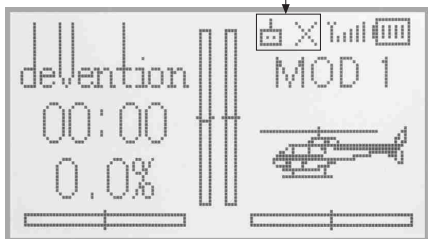

Trainee is working and trainer is off

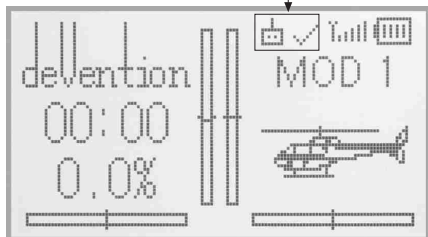

Trainer icon

Training status display: when the trainer's icon becomes into "X", the trainee stops flying and the trainer is working; when the trainer's icon turns into "✓", the trainee is flying and the trainer is in leisure.

(3) Usage method

The training switch can be freely switchable between Left trim and Right trim. The default setting is Right trim. Shown as below:



During flight, if the trainer pushes Right Trim once, the linkage icon will be shown as "✓" that means the control right is moved to the trainee from Trainer. If trainer pushes Right Trim once again, the linkage icon will be shown as "X" that means the trainer takes back the control right from the trainee.

(4) Setting for training function channels

Trainee is available to get full or part of flight control power to the aircraft model via setting the training function channel in the trainer's radio. Below is the setting method:

Push the ENT button to enter main Menu, and then push UP or DN to get access to function menu. Then push UP or DN to select "training function" and push ENT button to enter Trainer screen interface. The available channels are shown below, and the current status of trainer switch is also shown there.



Trainer switch selection: Press UP or DN to select the switch option; press R or L to select the switch which you want. It includes right and left trim. The default setting is Right trim.

Channel selection: Press UP or DN to select the channel option; Press R or L to select the channel(s) which you want to grant to trainee. The channel(s) you have selected will be activated as "Active". The channels which are not granted to trainee will be kept inhibited. The default setting is "Inhibit".

Press EXT to exit.

3.18 Timer

There are two timers which can be set as stopwatch and countdown, respectively. Each timer can be operated by switch or by shortcut.

Setting method:

Press ENT to enter Main Menu, and then press UP or DN to get access to Function Menu. Then push UP or DN to select "Timer" and press ENT to enter Timer interface. The timing range of stopwatch is from 0 to 59:59 (59 minutes 59 seconds). The default setting is stopwatch.

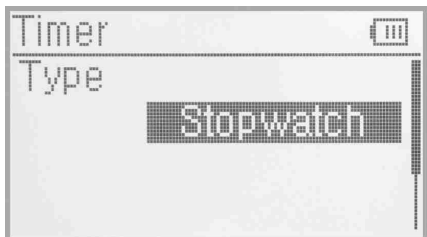

(1) Countdown setting

If you need countdown time manner, press R or L to select the countdown. There is an expand sub-menu set time item. Press UP or DN to move the navigational mark to select the option of Setting time item. Press R or L to set the countdown time. The settable countdown time range is from 00:05 to 59:55.

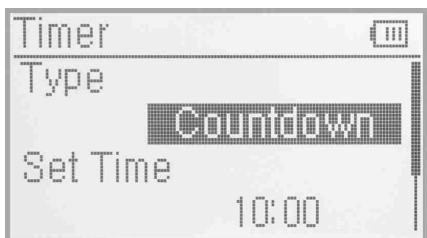

(2) Switch selection

Press UP or DN to move the navigational mark to Switch. There are Inhibit and available switch options, available switch can be selected by press L or R. It includes FMOD1,2, FMOD2, MIX1,2, MIX2, ELEV D/R, AILE D/R, RUDD D/R, GEAR SW, SPS0 SW, SPS1 SW, SPS2 SW and SPS3 SW. We can select the desired item except these items of SPS0 SW, SPS1 SW, SPS2, and SPS3 which should be previously set at Stick Position Switch at Model Menu (refer to "2.8 Stick Position Switch").

Press EXT to exit after finished.

(3) Usage of timer

Press UP or DN in main panel. It's possible to start Timers by pressing UP key for one time, and to pause it by pressing it the second time. Press DN to clear timer. It's ok to control time by Switch when time setting is finished on switch. Timer will be shown in main interface, as below illustration:

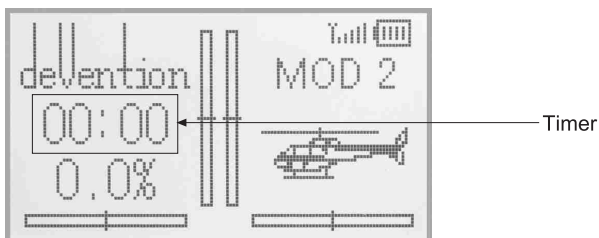

devention

DEVO-10

Part three Airplane

All the functional settings, which are relative to the operation system of DEVO-10 itself, are fully integrated in System Menu. They include Language, Display, Buzzer, vibrator, Stick Mode, Stick Direction, Stick calibration, and About.

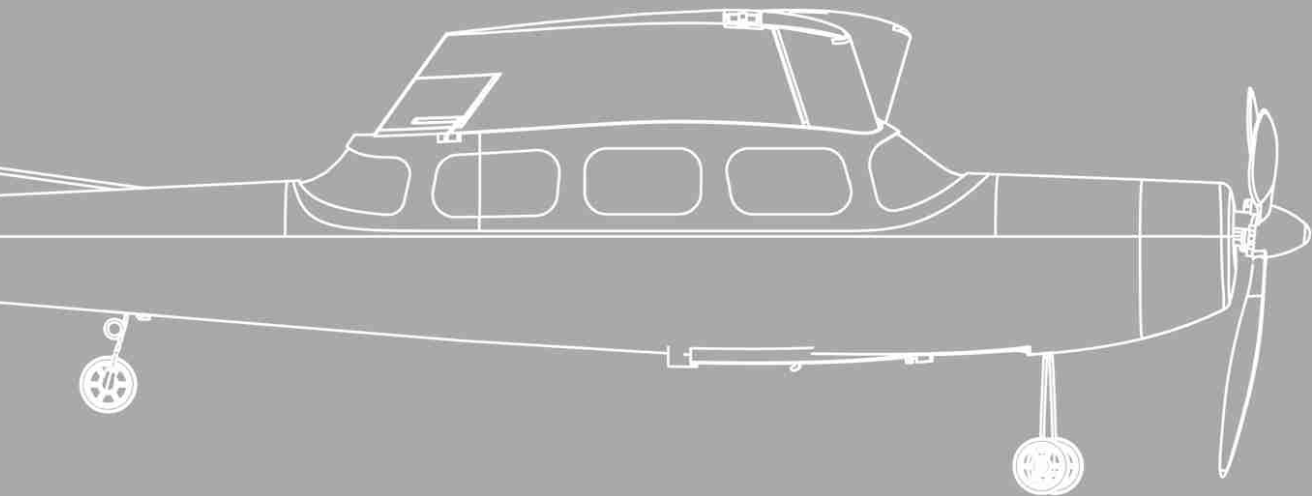

1.0 System Menu

All the functional settings, which are relative to the operation system of DEVO-10 itself, are fully integrated in System Menu. They include Language, Display, Buzzer, vibrator, Stick Mode, Stick Direction, Stick calibration, and About.

Below is the boot screen of helicopter:

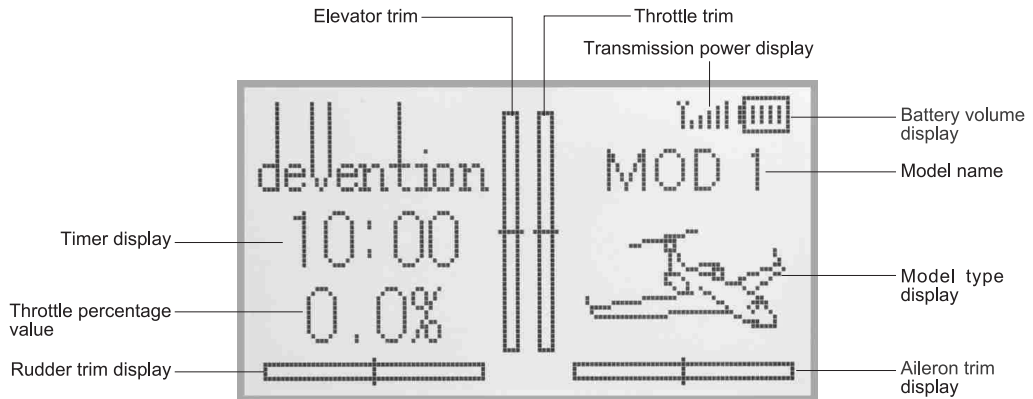

1.1 Language setting

Press ENT to enter System Menu and then press UP or DN to move the navigational mark to select System menu. Then push ENT to enter System menu. Press UP or DN to select Language and press ENT to enter the language interface. Press UP or DN to select the language that you want. A "✓" will be shown on the screen after selected. Push EXT to exit.



1.1 Language setting



1.2 Display

1.2 Display

Press ENT to enter the Main Menu and push UP or DN to move the navigational mark to select System menu. Press ENT to enter System Menu and then press UP or DN to select Display to enter "Display" interface. Three items are available to be set. Below are the setting methods for them:

- (1) Backlight contrast: the backlight contrast is adjustable by pushing UP or DN to move the navigational mark to the digits after Contrast. Press R key to increase the backlight contrast, while press L to decrease it.
- (2) Backlight lightness: the backlight lightness is adjustable by pressing UP or DN to move the navigational mark to the digits after Lightness. The power consumption will be increased if the backlight lightness is too bright and the battery cruise duration will be shortened. Press R or L to increase or decrease the lightness. When the value is one means turn off the backlight.
- (3) Backlight time out: it is possible to set the duration which LCD stays at highlight in the form of "Always on" or any period from 5 to 60 seconds with an interval of 5 seconds. Press UP or DN to move the navigational mark to select the digits after Timeout. Press L to short the time of backlight duration or keep it in the form of "Always on" while push R or prolong the time. The maximus is 60s.

Press EXT to exit.

1.3 Buzzer warning

Press ENT to enter the Main Menu and press UP or DN to move the navigational mark to select system menu then press ENT to enter System menu. Press UP or DN to select Buzzer and press ENT to enter the buzzer interface.

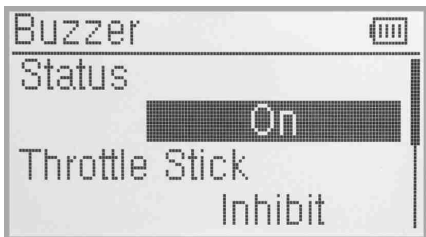

(1) Status: There are On and Off two status on the Buzzer interface. Press UP or DN to move the navigational mark to the status option. Press R or L to change the ON or OFF status. It includes Thro stick, knobs and Tones items under the status is ON.

(2) Throttle stick buzzer: Press UP or DN to move the navigational mark to Thro Stick item then press R or L to change the status from Inhibit to Active. When Buzzer is at the status of On, if Throttle Stick is set as "Active", a relative musical scale will make response when moving the throttle stick. You can judge the position of the throttle stick according to the different musical scales. Also, it can be set as Inhibit. Press UP or DN to move the navigational mark to Thro Stick item and push R or L to change the status from Inhibit to Active.

(3) Knobs midpoint Buzzer: When Buzzer is at the status of On, if Knobs is set as "Active", there is buzzer sound when you turn the AUX4 and AUX5 to the midpoint. If you don't need the buzzer sound, please change the status to Inhibit.

(4) Buzzer tone: the tone is composed of 10 grades. You can choose the favorite one according to your interests. Press UP or DN to move the navigational mark to Tone item and press R or L to make a listening test.

Press EXT to exit.

1.4 Vibrator

The vibrator used as an alarm function to remind the users.

Press ENT to get the Main Menu, press UP or DN to select System Menu. And then press ENT to get System Menu, press UP or DN to select Vibrator. Press ENT to get Vibrator setting interface. There are two status as Inhibit and Active. Press R or L to select Active if need.

Press EXT to exit after finished.

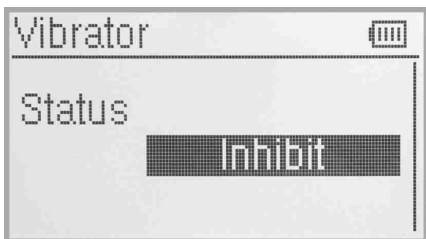

1.5 Stick Mode

Press ENT to get Main Menu, press UP or DN to select System Menu, and then press ENT to the System Menu, press UP or DN to select Stick Mode, and press ENT to get Stick Mode setting interface.



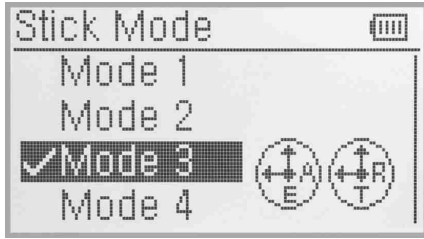

Select the stick mode according to the throttle mode showing on the screen. Devo-10 offers 4 stick modes, please refer to “8.0 Switches exchange between left-hand and right-hand throttles.

Press EXT to exit after finished.

1.6 Stick Direction

Press ENT to get Main Menu, press UP or DN to select System Menu, and then press ENT to the System Menu, press UP or DN to select Stick Direction, and press ENT to get stick direction setting interface.

Stick Direction: There are four items available as Elevator, Aileron, Throttle and Rudder. Press UP or DN to select the stick which will change direction, and press R or L to change the direction. The factory setting is Normal.

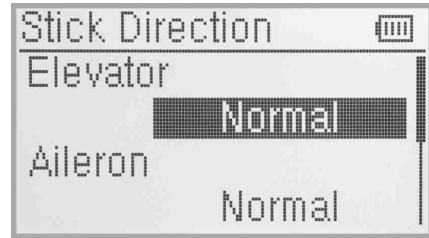

1.7 Stick Calibration

It is a function to re-calibration when stick unusual.

Calibration method:

Press “ENT” to the Main Menu, press UP or DN to select System Menu, then press ENT to System Menu. Press UP or DN to select Stick Calibration and press ENT to the Stick Calibration setting interface. Press ENT to enter Calibration, and below interface shows:

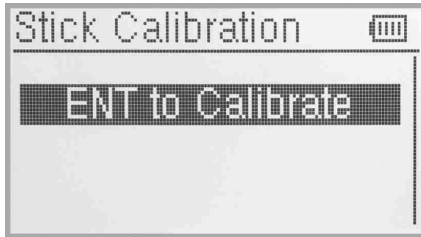

Clockwise or counter clockwise mechanically move the right stick and left sticks from minimum levels to maximum levels several times, and then return the sticks to the neutral positions, respectively. It will show the calibration successful after you press ENT to confirm.

Press EXT to exit after finished.

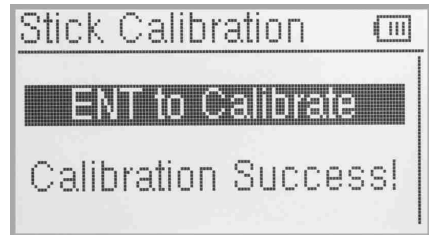

1.8 About

Press “ENT” to the Main Menu, press UP or DN to select System Menu, then press ENT to System Menu. Press UP or DN to select About and press ENT to the About setting interface.

Press EXT to exit after finished.

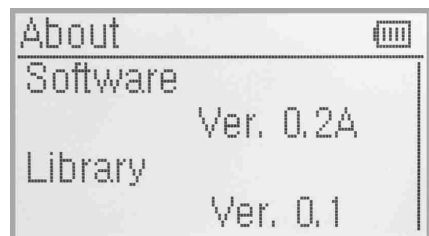

2.0 Model Menu

Model Menu manages all the model data saved in DEVO-10. It includes Model Select, Model Name, Model Copy, Model Transmit, Model Receive, Model Reset, Type Select, Trim System, Stick Position Switch, Device Select, Device Output, Wing Type, Power Amplifier, Fixed ID and Sensor setting.

2.1 Model Select

Press ENT to get Main Menu and press UP or DN to make Model Menu selected. Press ENT to get the Model Menu and press UP or DN to Select Model select, press ENT to get the Model Select setting interface.

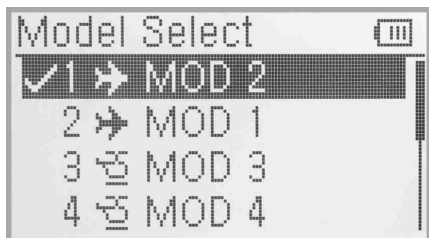

Press UP or DN to select the model you desired, press ENT to confirm and marks “✓” in the front of selected one. Total 30 models are optional. Press EXT to exit after finished.

2.2 Model Name

In the menu of model name, you can make a desired name for your model for long term storage. Its data can be directly withdrawn in next flights. Repeat the step “2.1 Model Select” to choose the model you want to name or save, press EXT to back to the interface.

Press “ENT” to enter Main Menu, press UP or DN to select “MODEL Menu”, then Press “ENT” to enter Model Menu; Press UP or DN to select “Model NAME” and then press “ENT” button to get the “Model Name” setting interface.

Press UP or DN to select the character and figure which are needed to be changed, press R or L button to change the character and figure, and press UP or DN to set next one. Press EXT to exit after finished.

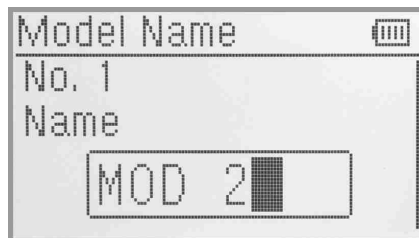

2.3 Model Copy

Press ENT to get “Main Menu” and press UP or DN to make “Model Menu” is selected. Press ENT to get “Model Menu” and press UP or DN to select “Model Copy”, press ENT to the “Model Copy” setting interface. Press UP or DN to choose the model you want to be copied as source model and press ENT to confirm, The serial No. and model name of Source Model will be shown as illustrations.

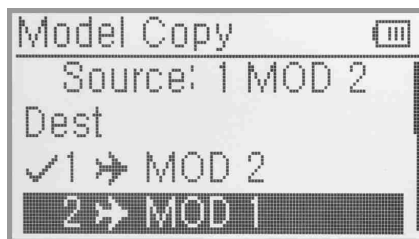
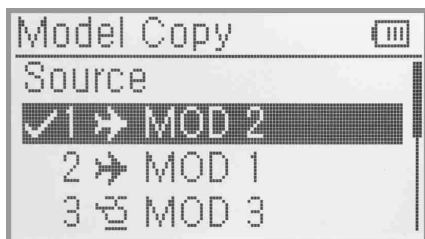

Then press UP or DN to locate the source model, press ENT to confirm. Then an enquire “Are you sure?” is popped up as illustrations. Press ENT to copy, or press EXT to exit.

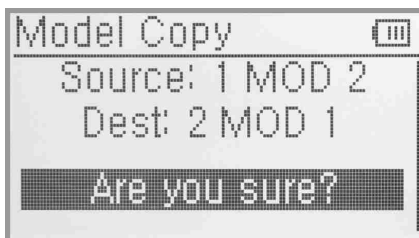

2.4 Model wireless copy

The model data between two DEVO-10 equipments can be wirelessly copied via Model Transmit and Model Receive in Model Menu.

(1) Model transmission

Press ENT to enter “Main Menu” and press UP or DN to select “Model Menu”. Press ENT to get “Model Menu” and press UP or DN to select “Model transmission”, continue to press ENT to enter “Model Transmit” setting interface.

Press UP or DN to choose the source model which will be transmitted, and press ENT to confirm, an enquiry information “Are you sure?” will be shown as illustrations.

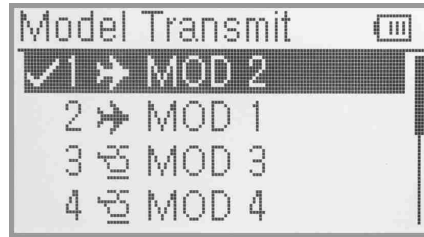

Press ENT to transmit, “Transmitting” appears in the interface. Or press EXT to exit. Press EXT to exit after another Devo-10 received the data.



(2) Model receiving

Press ENT to enter Main Menu and press UP or DN to select Model Menu. Press ENT to get Model Menu and press UP or DN to select Model Receiving, continue to press ENT to enter Model Receive setting interface. An enquiry information “Are you sure?” will be shown as illustrations.

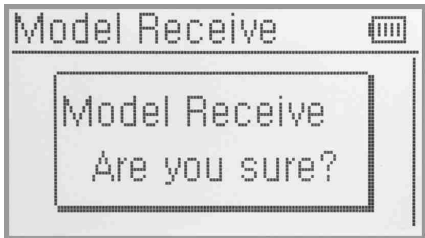

Press ENT to receive, “Connecting” and “Receiving” will be shown in series in the interface. The information of “Received” with the model name will be shown after receiving is finished. Or press EXT to exit.

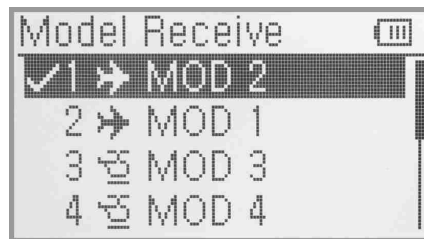
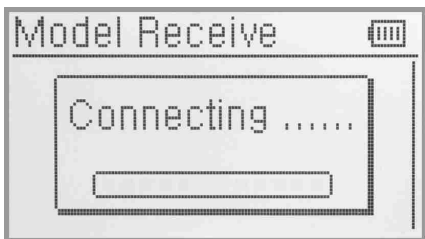

Press UP or DN to choose the save position, an enquiry information “Are you sure?” is shown after press ENT. Press ENT to save or press EXT to exit.

Press EXT to exit after finished.



2.5 Model reset

All the model data can be restored to factory setting via Model Reset.

Press ENT to get Main Menu and press UP or DN to select Model Menu. Press ENT to get Model Menu and press UP or DN to select Model Reset, press ENT to get Model reset setting interface.

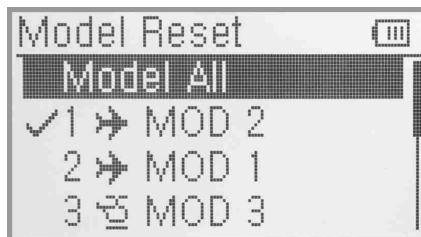

It is possible to store up to 30 models data in the model list of DEVO-10 equipment. There are two methods to reset the model data: batch reset and single reset.

Batch reset: press UP or DN to select All Models, an enquiry information “are you sure?” will be appears in the interface. Press ENT to reset all models, or press EXT to exit.

Single reset: Press UP or DN to choose the model you want to restore, “Are you sure?” will appear after press ENT. Press ENT to reset or press EXT to exit.

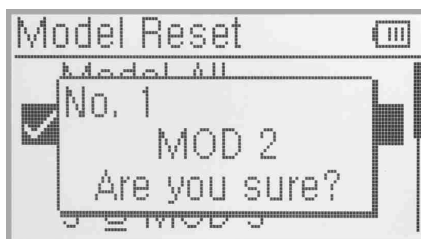

Press EXT to exit after finished.

2.6 Type Select

This device offers two model types menu. They are helicopter and airplane respectively.

Press ENT to get Main Menu and press UP or DN to select Model Menu. Press ENT to enter and press UP or DN to select Type Select and press ENT to enter setting interface.

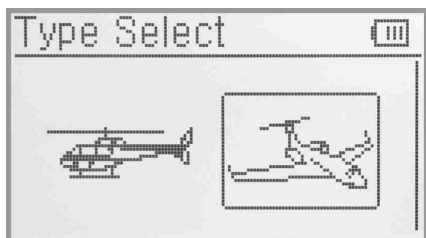

Press “ENT” button to get Helicopter and Airplane selections and press UP or DN to select and press ENT to confirm, then press EXT to exit.

2.7 Trim System

Trim System is able to finely tune the following six items, respectively: Elevator, Aileron, Rudder, Throttle, Left Trim and Right Trim. The trim range is divided into 20 grades (factory default is set at 4). It is convenient to subtly modify the pitch by adjusting the trim range.

Press ENT to get Main Menu and press UP or DN to select Model Menu. Press ENT to enter and press UP or DN to select Trim System, press ENT to enter setting interface.

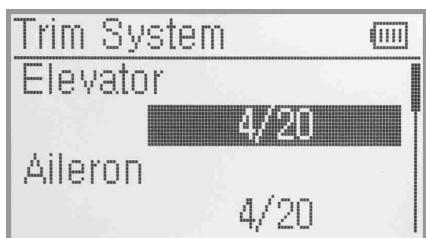

Press UP or DN to select the trim which will set, press R to increase the trim value and press L to decrease. For elevator, aileron, and rudder, there are two more options: Normal and Limited, press R or L you can change the setup. "Normal" means the trim is always working although the corresponding stick stays anywhere. "Limited" means the trim is out of working when the corresponding stick is at maximum position.

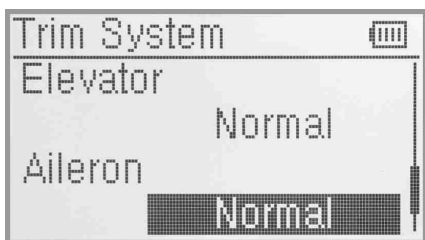

Press EXT to exit after finished.

2.8 Stick Position Switch

According to the following setting, the switch can be used as a switch. The turn-on or turn-off position at which stick stays can also be settable.

Method for setting:

Press ENT to get Main Menu and press UP or DN to select Model Menu. Press ENT to get Model Menu and press UP or DN to select Stick Position Switch, press ENT to get Stick Position Switch setting interface.

There are four options under the Stick position switch: SPS0, SPS1, SPS2, SPS3. Press R or L to choose the switch you want to define.



Press UP or DN to inhibit channel in navigation mark, and press R to expand the menu. The channel includes four items: Elevator, Aileron, Throttle and Rudder. The factory default is Inhibit. Take Elevator for example.

Press R or L to choose the Elevator as stick, then Press UP or DN to move navigation mark to value of position. It's possible to adjust the stick position via pressing R or L.



Press UP or DN to navigate the OPEN setting, press R or L to change the direction of the channel stick.

Press UP or DN to navigate the STATUS, which can check the sketch map of the stick OPEN/CLOSE direction. Check if it was set correctly.

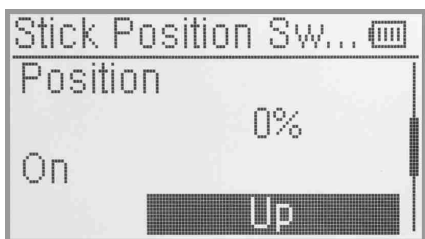

After finished the setting, press EXT to exit.

2.9 Device select

This setting can help you configure various functional switches, or adjust levers. It includes Flight Mode switch, Flight Mode trim, Throttle hold Switch and Flap Switch select, Flap Trim select.

Press ENT to enter Main Menu, press UP or DN to move navigation mark to select Model menu. Press ENT to enter Model menu function. Press UP or DN to select Device Option. Press ENT to Device Option interface.



(1) Flight Mode Switch

Press UP or DN to move navigational mark to Flight Mode Switch item and press R or L to select the desired switch. The factory default setting is FMODE switch.

(2) Flight Mode Trim

There are two modes: Common and Flight Model. In common mode all the trim values, to which various sticks are relative, put equally effects on all the flight modes. In

Flight Mode, the Trim values to which each stick is relative put, respectively, effect on the corresponding stick.

Press UP or DN to move navigational mark to Flight Mode Trim, press R or L to select Common or Flight Mode. The factory default is Common.

(3) Throttle Hold Switch

Refer to (1) Flight Mode Switch.

(4) Flap Switch Select

Refer to (1) Flight Mode Switch.

(5) Flap Trim Select

Refer to (1) Flight Mode Switch. After finished the setting, press EXT to exit.

2.10 Device Output

Device output can set up the output switches respectively. It can also activate, inhibit or use other functions. There are eight items in total: FMODE switch, MIX switch, ELEV D/R switch, AILE D/R switch, RUDD D/R switch, GEAR switch, SPS0, SPS1, SPS2, SPS3, left trim, right trim, AUX4 knob, AUX5 knob.

Setting:

Press ENT to enter Main Menu, press UP or DN to move navigational mark to Model Menu. Press ENT to enter Model menu. Press UP or DN to select Output device and press ENT to enter Output device interface.

Below six items can be adjusted: Gear, Flap, AUX2, AUX3, AXU4 and AUX5.



(1) Gear

Press UP or DN in output interface can change the gear switch. It includes FMODE, MIX, ELEV D/R, AILE D/R, RUDD D/R, GEAR, SPS0, SPS1, SPS2, SPS3, Left trim, Right trim, AUX4 knob, AUX5 knob. Press R or L to select the setting switch, The default setting is GEAR SW.

Press UP or DN to select Function setting after you select the switch, Press R or L enter the interface of Gear active, inhibit and Governor. The default setting is Active. You can continue to set other items after finished.



(2) Flap

Press UP or DN to move navigational mark to Function setting below Flap. The factory default setting is System Output setting.

It's possible to change via pressing L to show Flap Output setting.

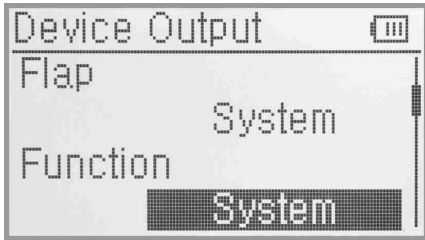

Press UP or DN to move navigational mark to Flap. Press R or L to expand the menu including FMODE SW, MIX SW, ELEV D/R, AILE D/R, RUDD D/R, GEAR SW, SPSO, SPS1, SPS2, SPS3, Left trim, Right trim, AUX4 lever and AUX5 lever. The default setting is MIX SW.

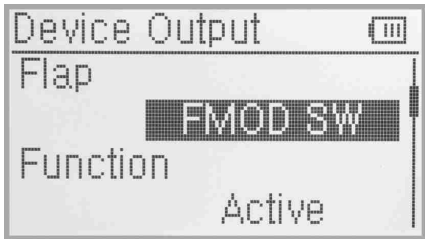

Press UP or DN to move navigational mark to Function setting. Press R or L to select the items you want to set up. And the items includes Inhibit, Active and System. Continue to set up other items after setting finished.

(3) AUX 2

Press UP or DN to enter the AUX2 interface. Press R or L can change the AUX2 switch. It includes FMODE, MIX, ELEV D/R, AILE D/R, RUDD D/R, GEAR, SPSO, SPS1, SPS2, SPS3, Left trim, Right trim, AUX4 knob, AUX5 knob, The default setting is FMODE switch.

Press UP or DN to select the Function setting, press R or L to choose the switch, it includes inhibit, activate, Gyro, Governor, the default setting is Gyro. You can continue to set other items after finished .

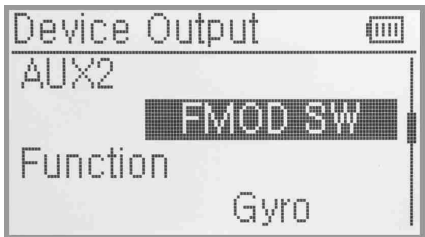

(4) AUX3

Press UP or DN to enter the AUX3 interface. Press R or L can change the AUX3 switch. It includes RUDD D/R, GEAR, SPSO, SPS1, SPS2, SPS3, Left trim, Right trim, AUX4 knob, AUX5 knob, The default setting is RUDD D/R switch.

Press UP or DN to move navigation mark to Funtion setting. Press R or L to desired item. The optional items are Inhibit, Active, Gyro and Governor. The factory default is Active. Continue to set up other items after setting finished.



(5) AUX4,AUX5 settings please refers to the AUX3 settings. AUX4 default setting is AUX4 knob, AUX5 default setting is AUX5 knob.

After finished the setting, press EXT to exit.

2.11 Wing Type

Wing Type is grouped into Nomal, Flaperon, DELTA, 4-Aileron and V -Tail.

Wing Type selection:

Press ENT to enter Main Menu, press UP or DN to move navigation mark to Model Menu. Press ENT to enter Model Menu. Press UP or DN to choose Wing Type, and press ENT to enter the Wing Type interface. Press UP or DN to move navigation mark to Wing Type. Press R or L to choose Wing Type. The Wing Type are Nomal, Flaperon, DELTA and 4-Aileron.

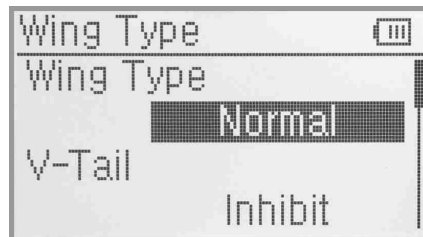

(1) Flaperon

Press R or L to choose Flaperon under Wing Type.

Below is the sketch map of Flaperon servos' assignment:

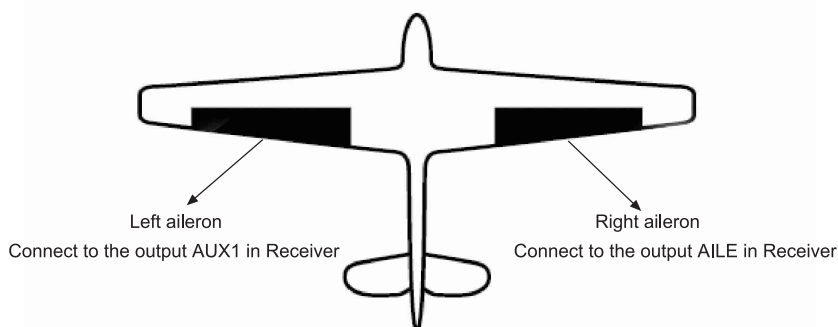

(2) DELTA

Press R or L to choose DELTA in Wing Type.

Below is the sketch map of DELTA servos' assignmanet:

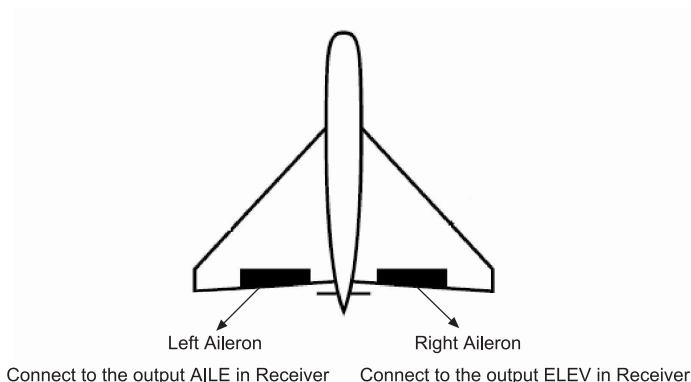

(3) 4 Aileron

If your model airplane is equipped two left aileron servos and two right aileron servos, we recommend you to use 4-Aileron function.

Press R or L to choose 4-Aileron in Wing Type setting. The channel assignment(Refer to Servo monitor):

The left aileron servos should be connected to the Output GEAR and AUX3 in the receiver, and the right aileron servos connected to AILE and GYRO in the receiver.All the servos' parameters can be adjusted respectively.

(4) V-tail

Press UP or DN to move navigation mark to V-TAIL under V-Tail interface. There are Inhibit and Active, please choose Active. V-tail is unadjustable when the Wing type is DELTA.

Below is the sketch map of servos' assignment in V-tail:

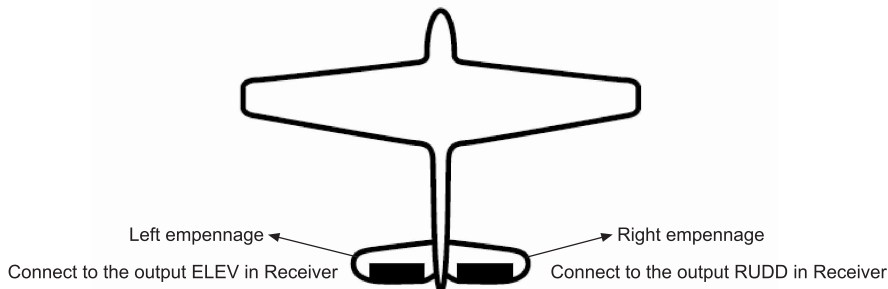

(5) Dual channels setting

Dual Channels can be set as Elevator, Aileron, Rudder, or Flaperon. It is of dual channel output function. The channel, which will be set as dual channel at AUX in Device Output (Refer to "2.11 Device Output"), should be previously set as Inhibit when the AUX channel is being set.

Setting method:

Channel setting: Press UP or DN to move the navigational mark to item Dual Channels in the interface of Wing Type. Pressing R or L, there are items of Elevator, Aileron, Rudder, and Flap. We take Elevator as an example.



(5.1) Mate setting: Press UP or DN to select "Dual Channels" setting, press R or L to select the desired channel in the menu with Inhibit and the inhibited channels previously set in "Device Output".

(5.2) Trim Setting: Press UP or DN to select "Dual Channels" setting, press R or L to select the item you want to choose as trim lever in the menu with Inhit, Left trim, Right Trim, AuX4 and AUX5.



(5.1) Mate setting



(5.2) Trim Setting

The setting of Aileron, Rudder and Flap in the item Channel are same as above.

(6) Twin Engine

This function can be set as twin engine output to meet the requirement for the models, which are powered by twin engines.

(6.1) Mate setting: Press UP or DN to select "Twin Engine" setting, press R or L to choose the desired channel in the menu with Inhibit and the inhibited channels previously set in "Device Output".

(6.2) Trim Setting: Press UP or DN to select "Dual Channels" setting, press R or L to choose the item that you want to select as trim lever in the menu with Inhibit, Left trim, Right Trim, AUX4 and AUX5.



(6.1) Mate setting



(6.2) Trim Setting

Press EXT after setting finished.

2.12 Power Amplifier

The transmission output power of DEVO-10 is adjustable. It is divided into six grades from small to big. The lower the transmission output power transmits, the shorter the radio range is, and the longer the stand-by time will be, the higher the transmission output power, the farer the radio range, and the shorter the stand-by time. Choose the appropriate transmission output power according to the actual situation.

Press ENT to enter the main menu. Press UP or DN to choose "Model menu" and then press ENT to enter the interface. Press UP or DN to choose the appropriate output power , press ENT to confirm.

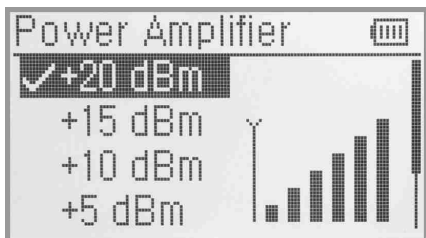

Press UP or DN to choose the requiring AMPLI. Press ENT to confirm then the corresponding items will have the "✓" mark in front of the items. The AMPLI rate will be shown on the interface.

After the setting, press EXT to exit.

2.13 Fixed ID

This setting will bind DEVO-10 with its receiver in a unique corresponding relationship. It will greatly speed up the time of automatic binding when DEVO-10 powered on.

(1) Setting for fixed ID

The setting for fixed ID should be under the status that automatic ID binding is successfully finished. Below is the setting method.

Press ENT to enter the main Menu and push UP or DN to move the navigational mark to select Model menu. Press ENT to enter Model Menu. Press UP or DN to select Fixed ID and press ENT to enter the Fixed ID setting interface.

If you want to activate the fixed ID settings, press R or L to change the status from off to On. A series of random digits will be shown below after change to On.

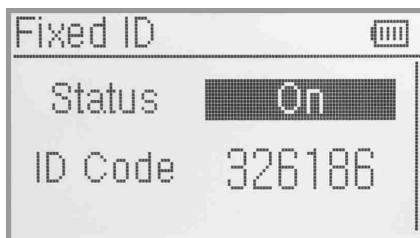
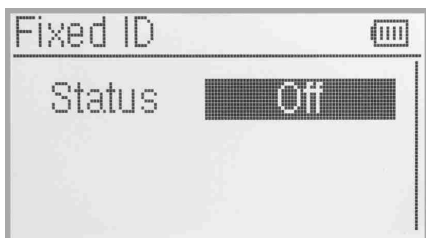

Press UP or DN to choose the ID code setting, press R or L to choose the words or number, press UP or DN moves to the next code setting. There are 6 words can be set to ID code.

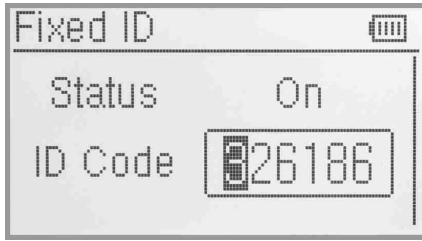

Press ENT key after the new ID has been set. An inquiry interface of "Are you sure?" pop up. "ID Code Matching" will be shown after press ENT. After matching, the interface will be returned to Model Menu.

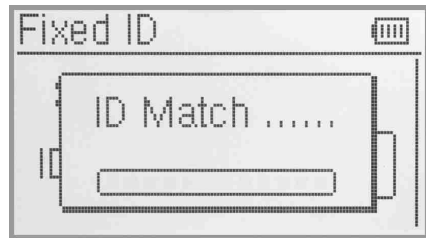

(2) Fixed ID cancellation

Insert the assorted BIND PLUG into the output terminal of BATT before the receiver is powered on, and then plug 5V DC power into other output terminal. The red light of receiver will flash slowly. This means the fixed ID code has been cancelled. Pull out bind plug. DEVO-10 also needs to make relative cancellation and revision after the fixed ID in receiver is cleared out.

In the main interface press the ENT to enter Model Menu and then press UP or DN to move the navigational mark to select MODEL MENU. Press ENT to enter MODEL MENU. Press UP or DN to select Fixed ID code and push ENT key to enter the Fixed ID code interface. Press UP or DN to select STATUS option, Press R or L to change the status to Off. Then press EXT to exit.



2.14 Sensor setting

Setting method: press ENT enter to the Main menu. Press UP or DN to select the Model menu. Press ENT enter to Model menu. Press UP or DN to select sensor press ENT enter to the sensor setting interface. See the Illustration.



Press R or L select Activate or Inhibit (the default setting is Inhibit), such as press Activate will includes No Signal Warning, Voltage sensor, Temperature sensor, GPS receiver setting etc.

(1) No Signal Warning

Press UP or DN to make the navigation mark choose "No Signal Warning". Press R or L to choose "inhibit" or "active" (default setting is "inhibit"). If you choose "Active", the Radio will alarm when telemetry signal lost. As following:



(2) Voltage setting

There are 3 different types of voltage can be measured.It includes Internal 5V,External V1 and V2 which can be monited two different external voltage(i.e. battery) respectively.Once the measured voltage is lower than the setting value, the Radio will alarm.

(2.1) Receiver 5V(Internal) PFV(Power Feeding Voltage) Alarmed value can be setted as 3.6-6V

Voltage setting: press R or L to activate the 5V, the alarm interface will appears in the interface , please refers to the Illustration.



Press UP or DN to select the Alarm Voltage setting,press R or L to set the value. The range is 3.6-6V. you can continue to set others items after you finished.

(2.2) External V1

Press UP or DN to enter to External V1 setting interface. Press R or L to activate the V1,the details refers to the Illustration.

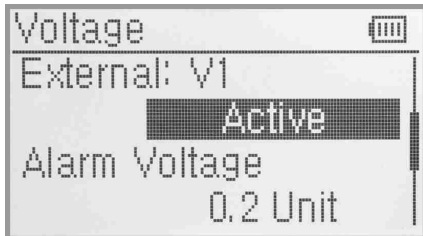

Press UP or DN to select the Alarm voltage setting. Press R or L to set the value. The setting range is 0.2~99.9V. you can continue to set others items after you finished.

(2.3) External: V2 setting can refers to External V1 setting.

Press EXT back to sensor setting interface after you finished.

(3) Temperature sensor

The temperature sensors can measure up to 4 different temperature(i.e.motors).You can choose Celsius or Fahrenheit.The alarmed value can be setted for 4 different temperature.Once the measured value is higher then the setting value,the radio will alarm.The Alarm Temperature value can be setted as -20~220°C or -4.0~428.0° F.

Temperature Setting:

In the "Sensor Setting"interface,press UP or DN to make the navigation mark choose "Temperature Sensor",and press ENT to enter "Temperature Sensor"setting interface. See the illustration.

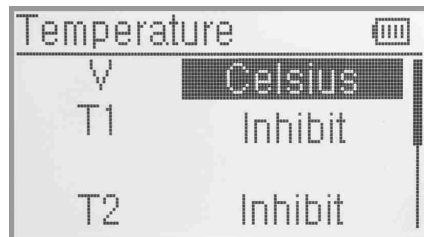

(3.1) Unit

Press UP or DN to make the navigation mark choose "Unit"setting item,and press R or L to choose Unit, two kinds of Unit:Celsius and Fahrenheit.

(3.2) Alarm Temperature settings

Press UP or DN to select the T1 ,Press R or L to activate the setting.Inhibit will change to Active and Alarm temperature will be shown. If you choose Inhibit, the Alarm temperature value won't be shown.



Press UP or DN to select "Alarm" setting, press R or L set the alarm temperature value. Press UP or DN to set other items after finished the setting.

(3.3) T2,T3,T4 setting

Refer to the step of "(3.2)T1".

(4) GPS setting

There are 4 items including Altitude Type, Speed Unit, Date type and time Zone in the GPS receiver setting interface. Press UP or DN to select the Sensor setting interface to enter the GPS setting interface.

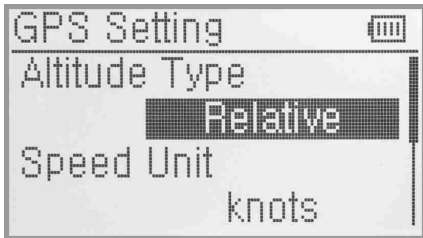

(4) GPS setting



(4.1) Altitude Type

(4.1) Altitude Type

Press UP or DN to select the Altitude type on the GPS setting interface and it's including Absolute and relative.

(4.2) Speed Unit

Press UP or DN to select the Speed Unit on the GPS setting interface and it's including knots and km/h and relative. Select the desired item.

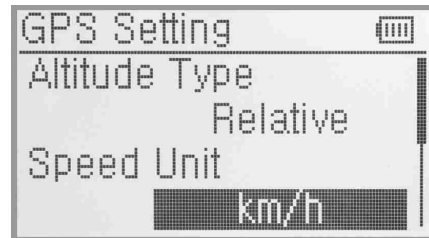

(4.3) Date Type

Press UP or DN to select the of Date Type on the GPS setting interface and it's including DD-MM-YY, MM-DD-YY and YY-MM-DD. Select the desired item.

(4.4) Time Zone

Press UP or DN to select the of Time Zone , press R or L to set the desired Time Zone.



(4.3) Date Type



(4.4) Time Zone

3.0 Function Menu

Function Menu can help you custom adjustments for the selected models. The menu includes such items as Reverse Switch, Travel Adjust, Sub Trim, Dual Rate and Exponential, Throttle Hold, Throttle Curve, Differential, Balance, Gyro Sensor, Governor, Aileron to Rudder Mix, Elevator to Flap Mix, Rudder to Aileron/Elevator Mix, Flap System, Aileron to Flap Mix, Program Mix, Monitor, Fail Safe, Sensor view, Trainer and Timer.

3.1 Reverse Switch

Press ENT in main interface to enter main menu; Press UP or DN to move the navigation mark to Function Menu. And press ENT to enter Function Menu, Press UP or DN to choose Reverse Switch and Press ENT to enter into Reverse Switch interface.

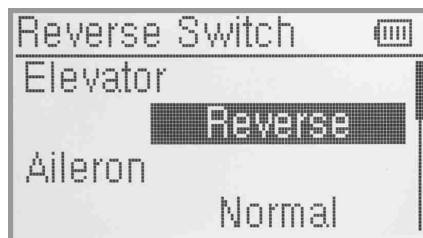
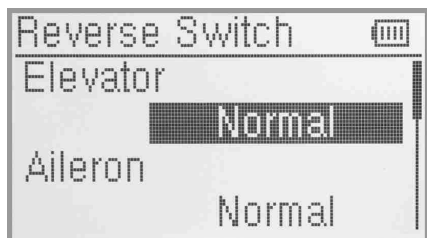

Press UP or DN to move navigation mark to ELEV (take Elevator for example), Press R or L to shift the status between normal and reverse. These are two status for option. And the default setting is Normal. All Channels Reverse Switch like: Aileron, Throttle, Rudder, Gear, Flap, Gyro, Aux3, Aux4 and Aux5 can be referred to the way of ELE Reverse Switch. And press EXT to exit after setting finished.

3.2 Travel Adjust

Press ENT to enter into main menu. Press UP or DN to move navigation mark to selected item Function menu. Press ENT to enter Function Menu. Press UP or DN to select Travel Adjust, Press ENT to enter Travel Adjust interface, as below illustration. It shows the Travel Adjust status of one channel:



Take ELEV for example, Press UP or DN to move navigation to desired item Elevation of U. Press R or L to increase or decrease the servo travel range. The adjustment range is from 0.0% to 150.0%. The factory default is 100.0%.

Press UP or DN to move navigation mark to desired item D of ELE. Press R or L to increase or decrease the servo travel range. The range is from 0.0% to 150.0%. The factory default is 100.0%.

All other channel's Travel Adjust like Aileron, Throttle, Rudder, Gear, Flap, Gyro, Aux3, Aux4 and Aux5 can be referred to ELEV travel Adjust. Press EXT to exit after setting finished.

3.3 Sub Trim

Sub Trim can parallel move the neutral point of the servo. But we advise you to mechanically adjust the servo bell crank if offset is far away from the neutral point of servo, because excessive usage of the sub trim may damage the servo.

Setting method:

Press ENT to enter Main Menu, Press UP or DN to move the navigation mark to desired item Function menu. Press ENT to enter Function menu, Press UP or DN to select Sub trim, and press ENT to enter Sub Trim interface.

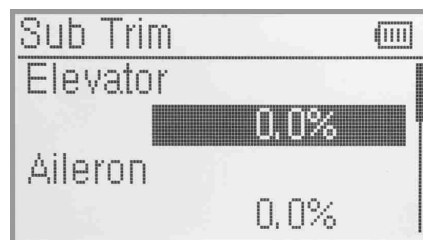

The interface shows the items and the channels which are adjustable. Press R or L to change the neutral point of Servos. The factory default is 0.0%. Press UP or DN to choose desired items. The range as below:

Channel name	Adjustment range	Channel name	Adjustment range
Elevator	D62.5% ~ U62.5%	Flap	D62.5% ~ U62.5%
Aileron	R62.5% ~ L62.5%	Gyro	-62.5% ~ +62.5%
Throttle	L62.5% ~ H62.5%	AUX3	-62.5% ~ +62.5%
Rudder	R62.5% ~ L62.5%	AUX4	-62.5% ~ +62.5%
Gear	-62.5% ~ +62.5%	AUX5	-62.5% ~ +62.5%

Press EXT to exit after adjustment finished.

3.4 Dual rate and Exponential

After this function is set up, it is possible for D/R switch to control the dual rates of elevator, aileron and rudder, respectively. The setting range is covered from 0% to 125%. Under the help with exponential curve adjustment, it is possible to make both customized setting and automatic setting. The switch between Dual rate and Exponential can be shifted via pushing or pulling the Flight Mode Lever.

Setting method

Press ENT to enter main menu. Press UP or DN to move navigation mark to desired item Function Menu. Press ENT to enter Function menu, press UP or DN to choose Dual rate and Exponential, Press ENT to enter D/R and Exponential interface.

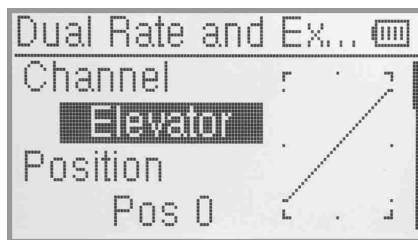

(1) Channel selection

Press UP or DN to move navigation mark of Channel, Press R or L to set up channels containing Elevator, Aileron and Rudder. Choose the desired channel for setting.

(2) Position selection

Press UP or DN to move navigation mark to desired item Position. In the manual mode, the function of Dual rate and Exponential will be executed by the corresponding D/R switch among Pos0 and Pos1. Take the item Elevator at channel as an example. It's possible to shift between Pos0 and Pos1 via pushing or pulling the D/R switch.



(3) Dual rate adjustment

Press UP or DN to move the navigation mark to desired item Dual Rate. It's possible to change the dual rate value of Position via pressing R or L and the corresponding value curve in the right top of interface will be changed accordingly. The factory default is 100%.

(4) Exponential

Press UP or DN to select Exponential item of navigation mark. It's possible to change Dual Rate and Exponential value in Pos when pressing R or L to change the value. There are ± 100% and Line three adjustment. At the same time, the corresponding curve will be changed and shown at the right graph.

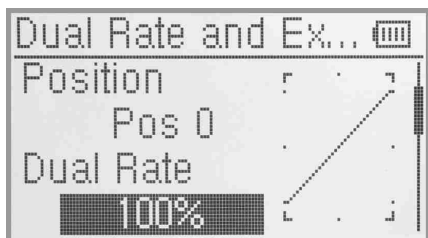

(3) Dual rate adjustment

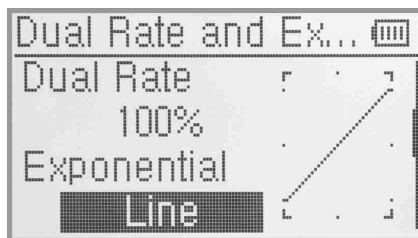

(4) Exponential

3.5 Throttle Hold

If this function is set, the switch will be executed by hold switch. The setting value of throttle hold is ranged from -20.0-50.0%. the default setting is Inhibit.

Setting method:

Press ENT to enter main menu, Press UP or DN to move navigation mark to select Function menu. Press ENT to enter Function Menu. Press UP or DN to select Throttle Hold, Press ENT to enter Throttle Hold interface, as below illustration:



Press R or L to activate Throttle Hold function, and expansion list will be shown as Throttle hold status, throttle hold position and Throttle hold switch.

- (1) There are two items under Throttle Hold Status: Active and Inhibit. The factory default setting is Inhibit.
- (2) Throttle Hold position

In the Throttle Hold interface, press UP or DN to make the Navigation mark choose “Throttle Hold Position” setting options. Press R or L to change data, the minimum value is -20.0%; the maximum value is +50.0%.

- (3) Throttle Switch setting

It's invalid for setting, the factory default is RUDD D/R which will be shown in the status item. When the Throttle Hold switch is on, data under the Throttle Hold can not be amended until Throttle Hold switch to be off, and the hold status is changed.



Press EXT to exit after setting up finished.

3.6 Throttle Curve

Throttle Curve are adjusted through 7 points.

Setting method:

Press ENT into interface to enter Main Menu, then press UP or DN to select “Function Menu” and press ENT to enter. Press UP or DN to select “Throttle Curve” and press ENT to enter setting interface. Please see below picture. A question “All Servos hold?” will pop up after enter “Throttle Curve” interface, press OK for all the servos locked at the current status, press Cancel for all the servos unlocked.

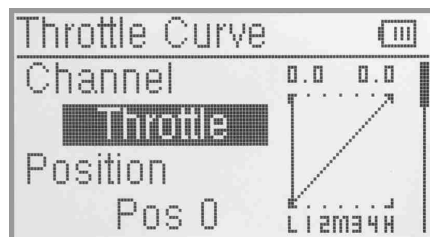
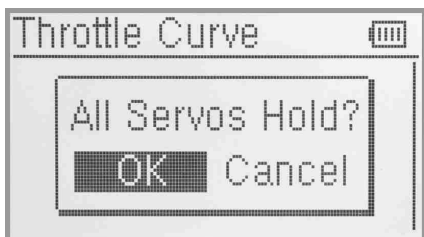

- (1) Channel setting

The default setting is Throttle Channel, and can not reset.

- (2) Position selection

Press UP or DN in the “Throttle Curve” setting interface to select “Position”, press R or L to select the item you want to set in the list with Pos 0 and Pos 1.

(3) Exponential setting

Press UP or DN in the “Throttle Curve” setting interface to select “Exponential” setting, Press R or L to set “OFF” or “ON”. The throttle curve will be changed smoothly if select ON. Select OFF if not need then the throttle curve will be shown as a line.

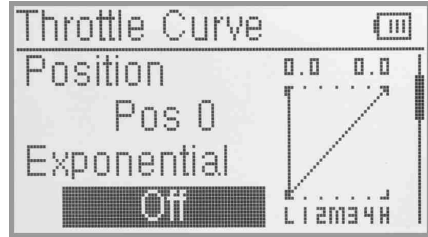

(4) Curve setting

Including “Point” and “Output ”.

(4.1) Point setting

Press UP or DN in Throttle Curve interface to select Points setting. Press L to expand a list including seven points: “Point-L”, “Point-1”, “Point-2”, “Point-M”, “Point-3”, “Point-4” and “Point-H”. Press R or L to select the point you want to adjust.

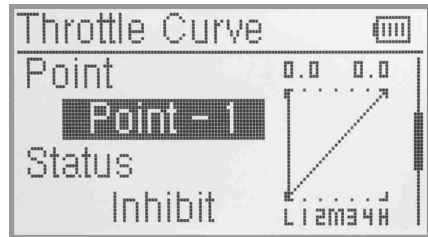
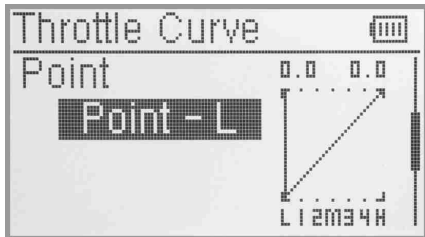

(4.2) Status setting

After above setup, press UP or DN to select Status setting, press R or L to set Inhibit and Active. Select Inhibit if for keeping the current value (the default setting is Inhibit). Select Active for changing the above points' value.

(4.3) Output setting

There is a expand item “Output” after select Status Active, press UP or DN to select Output setting, press R or L to decrease or increase, respectively, the output value. The adjustable range is from 0.0% to 100.0%, The curve graph in right will be change accordingly.

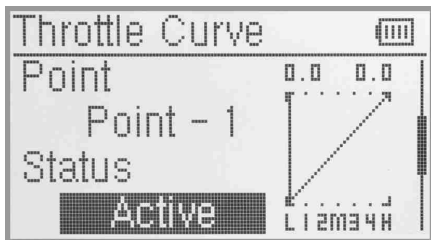

(4.2) Status setting

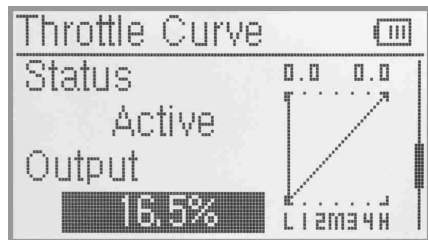

(4.3) Output setting

(4.4) Throttle setting

The switch between Pos 1 and Pos 0 can be freely realized through throttle stick after the below amount has been set up. The below set amount is the position of throttle stick as well as the switch point.

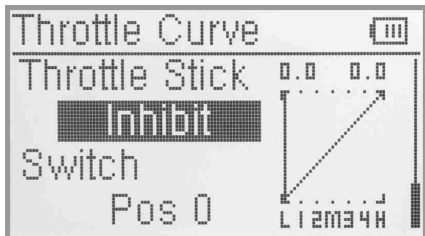

Throttle setting: Press UP or DN to select Throttle setting, Press L to decrease the amount with a lower limit of 0.0% or Inhibit, Press R to increase the amount with an upper limit of 100.0%.

(4.5) Switch Selection

When the item Throttle Stick is set in Inhibit, it is possible to switch between Pos 0 and Pos 1 by Switch. Press UP or DN to select "Switch". Press ENT to enter into Switch selection interface, press UP or DN to choose desired item. Press ENT, the desired item whose left side will be changed into "1" from "0". If two or more items are selected, the item should be chosen, whose left side should be changed into "1" from "0". Press EXT after finished it.

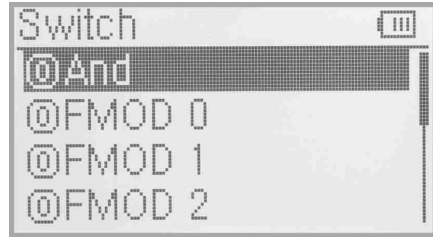

3.7 Differential

If want to use this function, Flaperon, DELTA, or 4-Aileron should be previously selected in Wing Type of Model Menu. Refer to "2.11 Wing Type".

(1) Aileron differential setting

Press ENT to enter into Main menu; press UP or DN to choose Function menu. Press ENT to enter into Function menu; press UP or DN to choose Differential, press ENT to enter interface of Differential, illustration as below.

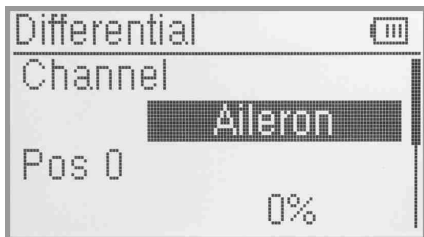

Mounting servos in left and right ailerons are a must if using this function. The following interface will be shown after Flaperon, DELTA, or 4-Aileron selected in Wing Type. Refer to "2.11 Wing Type".

(1.1) Channel

Current setting channel is Aileron. System default can not be set.

(1.2) Setting for Pos 0

Press UP or DN to choose Pos 0, press R or L to increase or decrease differential value, respectively. The adjustable range is ± 100%.

(1.3) Setting for Pos 1

Press UP or DN to choose Pos1, press R or L to increase or decrease differential value, respectively. The adjustable range is ± 100%.

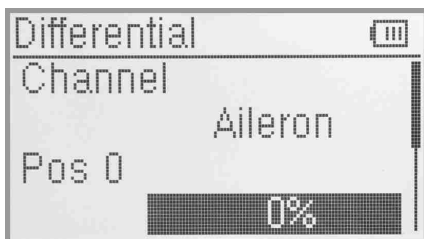

(1.2) Setting for Pos 0

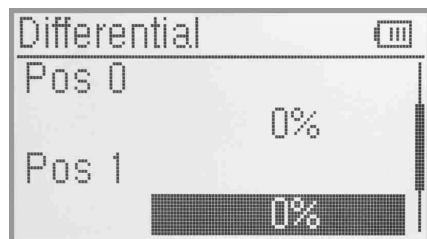

(1.3) Setting for Pos 1

(1.4) Switch selection

It is possible to switch by Setting Switch when differential is in use.

Press UP or DN to choose Switch, press ENT to enter interface of Switch selection, press UP or DN to choose desired item. Press ENT, the desired item whose left side will be changed into "1" from "0". If two or more items are selected, the item should be chosen, whose left side should be changed into "1" from "0". Press EXT after finished it.

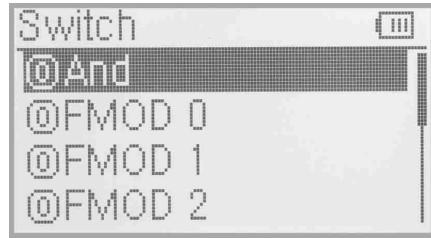
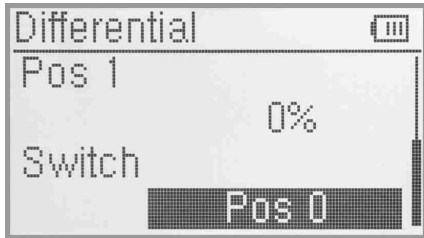

(2) Rudder differential setting

V-Tail should be previously set in Wing Type of Model Menu if the rudder differential function is activated. Refer to "2.11 Wing Type". And then the following interface will be shown:

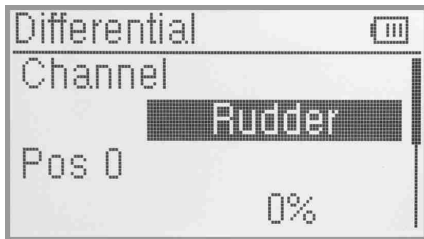

(2.1) Setting for Pos 0

Press UP or DN to choose Pos 0, press R or L to increase or decrease differential value, respectively. The adjustable range is $\pm 100\%$.

(2.2) Setting for Pos 1

Press UP or DN to choose Pos1, press R or L to increase or decrease differential value, respectively. The adjustable range is $\pm 100\%$.

(2.3) Switch selection

It is possible to switch by Setting Switch when differential is in use.

Press UP or DN to choose Switch, press ENT to enter interface of Switch selection, press UP or DN to choose desired item. Press ENT, the desired item whose left side will be changed into "1" from "0". If two or more items are selected, the item And should be chosen, whose left side should be changed into "1" from "0". Press EXT after finished it.

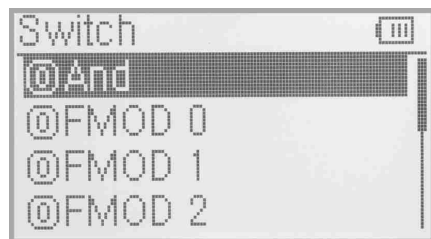
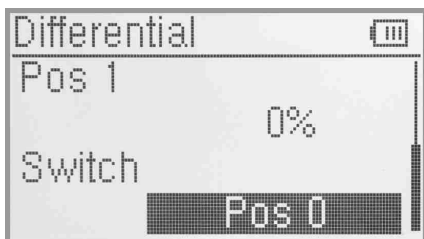

(3) Flap differential setting

It should be previously set the flap dual channel function in Wing Type of Model Menu (refer to "2.11 Wing Type") in order to activate the menu of Flap Differential.



(3.1) Setting for Pos 0

Press UP or DN to choose Pos 0, press R or L to increase or decrease differential value, respectively. The adjustable range is $\pm 100\%$.

(3.2) Setting for Pos 1

Press UP or DN to choose Pos1, press R or L to increase or decrease differential value, respectively. The adjustable range is $\pm 100\%$.

(3.3) Switch selection

It is possible to switch by Setting Switch when differential is in use.

Press UP or DN to choose Switch, press ENT to enter interface of Switch selection, press UP or DN to choose desired item. Press ENT, the desired item whose left side will be changed into "1" from "0". If two or more items are selected, the item should be chosen, whose left side should be changed into "1" from "0". Press EXT after finished it.

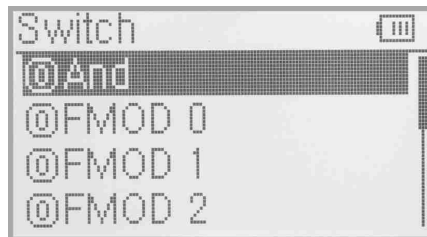
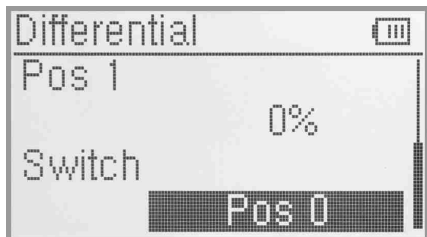

3.8 Balance

This function can adjust the parameters of the two servos which are used in the dual channels. It should be previously activated one of these wing types of Flaperon, DELTA, 4 Aileron, and V Tail in Wing Type at Model Menu. Refer to "2.11 Wing Type".

Setting method:

Press ENT to enter into Main Menu, press UP or DN to choose Function. Press ENT to enter into Function menu, press UP or DN to choose Balance. Press ENT to enter interface of Balance setting, picture as right:



(1) Channel: current setting channel is Aileron. System default can not be set.

(2) Point parameter adjustment

Point< Right Setting: Press UP or DN to choose "Point< Right". If need to adjust the value, press L (0% means no adjusting). A minus value means the amending direction is downward; press R to adjust value(0% means no adjusting). A plus value means the amending direction is upward. The adjustable range is ±100%.

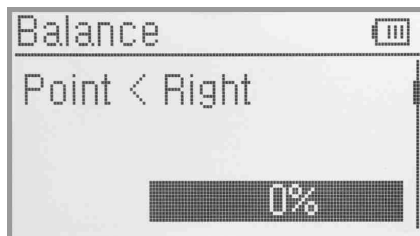

Point-Right Setting: Press UP or DN to choose "Point-Right". Press R or L to inhibit or active. If need to adjust please active it. There will be expanded value adjustment item. Press UP or DN to choose "0%" If need to adjust the value, press L (0% means no adjusting). A minus value means the amending direction is downward; press R to adjust value (0% means no adjusting). A plus value means the amending direction is upward. The adjustable range is 100%.

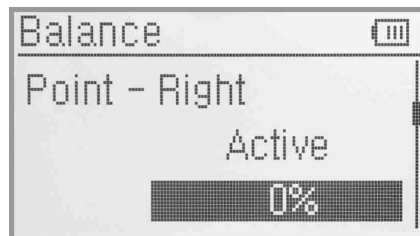
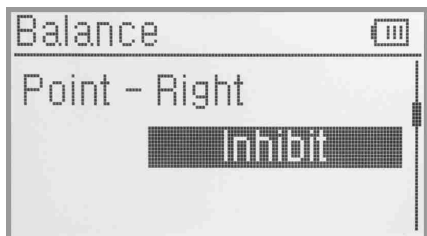

Press UP or DN, there will be setting for Point-1, Point-2, Point-3, Point-Left, Point>Left, refer to the setting method as above. Press EXT after finished it.

3.9 Gyro sensor

This function offers the gain adjustment for gyro sensor, which can be manually set through D/R switches or Flight mode switch, and also is possible to be automatically switched among various gains through flight mode switch. (The flight mode should be activated. Refer to “2.9 Device Select”).

Setting method:

Press ENT to enter Main menu; Press UP or DN to choose Function menu. Press ENT to enter Function menu; Press UP or DN to choose Gyro setting, press ENT to enter the setting interface of Gyro setting.



(1) Manual Setting

(1.1) Manual Setting: Under Gyro setting interface, press UP or DN to choose Mode, press R or L to get Manual setting or Automatic Setting (Automatic setting can be activated if Flight mode is act, refer to “2.9 Device selection”). Choose “Manual Setting”

(1.2) Channel: The default setting is AUX 2. It is possible to alter into other channels by choosing in the item of Device Output (refer to “2.10 Device Output”).

(1.3) Switch selection: Under Gyro setting interface, press UP or DN to choose Switch, press R or L to expand into six articles: FMOD SW, MIX SW, ELEV D/R, AILE D/R, and RUDD D/R., GEAR SW. Choose the desired switch for Manual control.

(1.4) Gain Setting: If the switch selection is three level, the gain settings of Pos 0, Pos 1, and Pos 2 can be setted respectively. If the switch selection is two level, then only Pos 0 and Pos 1 can be setted individually.



(1.4.1) Status: turn the setting gyro control switch, the status items will display the current switch status position.

(1.4.2) Pos 0: Press UP or DN to move the navigational mark to Pos 0 and press R or L to increase or decrease, respectively, the value. If the gyro used has two modes of NOR and AVCS, NOR will be activated when the value is less than 50.0%. In NOR mode, the smaller the value is, the bigger the gyro sensor gain will be. The factory setting is 50.0%.

(1.4.3) “Pos 1,” “Pos 2” are the same setting way as above “Pos 0”.

(2) Automatic setting

(2.1) Automatic Setting: in the Gyro Sensor interface, press UP or DN to select the item of Mode, press R/L to select Manual or Automatic options. Select Automatic.



(2.2) Channel: The default setting is AUX 2. It is possible to alter into other channels in the interface of Device Output (Refer to “2.10 Device Output”).

(2.3) Switch: The switch function isn’t available under Automatic setting.

(2.4) Status: turn the Switch “FMOD” or “throttle hold”, the status set display present flight mode position. There are “Flight Mode 0”, “Flight Mode 1”, “Flight Mode 2”, “Throttle hold” sets. “Throttle hold” need to start that can effect. (refer to “3.5 throttle hold”)

(2.5) Flight Mode 0: Press UP or DN to select Flight Mode 0, press R/L can increase or decrease the value individually. If the gyro used has two modes of NOR and AVCS, NOR will be activated when the value is less than 50.0%. In NOR mode, the smaller the value is, the bigger the gyro sensor gain will be. The factory setting is 50.0%.

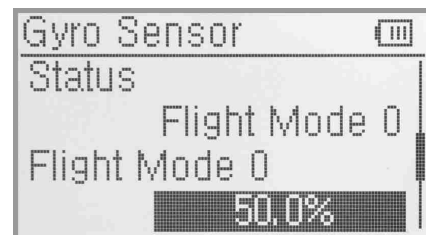

(2.6) Flight mode 1, Flight mode 2, Throttle hold settings refer to “Flight Mode 0”. After finishing the set, press EXT to exit.

3.10 Governor

Before setup this function, "Governor" should be set and activated in "Device output" interface. (Refer to 2.10 Device Output)

The control proportion of governor can be separately set in various flight modes. For the absolute revolution amount, please set in external governor. The amount shown in DEVO-10 governor is just a percentage for reference. The actual revolution should be read in the external governor.

Setting Method

Press "ENT" to enter the "Main menu" interface; Press "UP/DN" to make the navigation mark to select "Function menu". Press "ENT" to "Function menu"; Press UP/DN to choose "Governor" then press 'ENT' key to enter the Governor setting interface, which display the options of Status and channels; Press UP/DN, there are options of "Flight Mode 0", "Flight Mode 1", "Flight Mode 2", "Throttle Hold" and so on.



(1) Status

Turn the Flight Mode or Thottle hold switch, the status display present flight mode position. There are "Flight Mode 0", " Flight Mode 1", "Flight Mode 2", "Throttle Hold" and so on. Thottle hold can be available when the it has been activated (refer to 3.5 Throttle hold").

(2) Channel: The setted channels will display in "2.10 Device output" (refer to 2.10 Device Output)

(3) Flight Mode 0

Press "UP/DN" to make the navigation choose the "Flight Mode 0" set, press R/L to increase/decrease the value. The factory default value is 0%, adjustable range $\pm 125\%$.

(4) "Flight Mode 1", "Flight Mode 2", "Throttle hold" settings refer to "Flight Mode 0".

Press EXT to exit after finished.

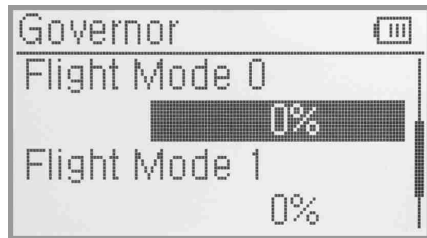

3.11 Aileron to Rudder Mix

This function is possible to execute the mix of aileron to rudder, which is controlled by switch.

Setting method:

Press ENT enter to Main menu, press UP or DN to select Function menu. Press ENT enter to Function menu. Press UP or DN select Aileron to rudder mix, press ENT to enter into Aileron to Rudder mix setting interface.

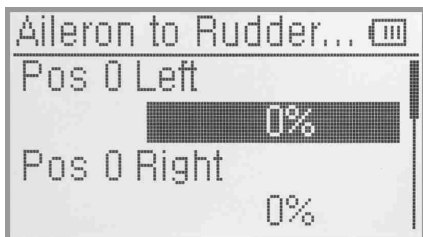

(1) Pos 0 Setting leftward setting

Press UP or DN select leftward mix value, press R or L, leftward mix value of aileron to rudder will be changed. The mix direction will be revised by changing the sign of plus or minus before the value. The adjustable range is $\pm 125\%$.

(2) Pos 0 Setting rightward setting

Press UP or DN to select rightward mix value, press R or L rightward mix value of aileron to rudder will be changed. The mix direction will be revised by changing the sign of plus or minus before the value. The adjustable range is $\pm 125\%$.

(3) Pos 1 setting, the setting is same as above.

(4) Throttle stick setting

The switch between Pos 0 and Pos 1 can be realized by setting the position of throttle stick. Press UP or DN of Throttle Stick to set the position amount of throttle stick. The default setting is Inhibit. The adjustable range is 0.0-100.0%.

(5) Switch setting

The switch will display the current switch position. press UP or DN to select the desired item press ENT to the setting interface and “0” before the item will be changed into “1”. If two or more items are selected, the item And should be selected. Press EXT to exit after finished.

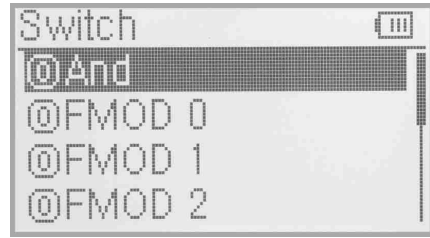

3.12 Elevator to flap mix

This function is used to execute the mix of elevator to flap.

Press ENT enter to main menu,press UP or DN to select function menu. Press ENT to enter to function menu. Press UP or DN to select Elevator to flap mix,press ENT to enter to Elevator to flap mix setting interface.

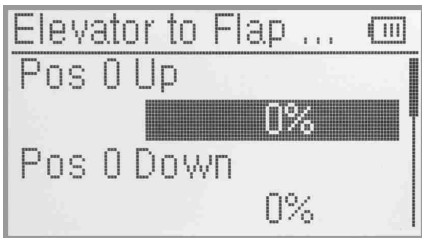

(1) Pos 0 UP setting

Press UP or DN to move the navigational mark to select item Pos 0 UP, press R or L upward mix value of Elevator to flap mix will be changed. The mix direction will be revised by changing the sign of plus or minus before the value. The adjustable range is $\pm 125\%$.

(2) Pos 0 Down setting

Press UP or DN to move the navigational mark to select item Pos 0 Down, press R or L downward mix value of Elevator to flap mix will be changed. The mix direction will be revised by changing the sign of plus or minus before the value. The adjustable range is $\pm 125\%$.

(3) Pos 1 setting, the setting is same as above.

(4) Throttle stick setting

The switch between Pos 0 and Pos 1 can be realized by setting the position of throttle stick. Press UP or DN of Throttle Stick to set the position amount of throttle stick. The default setting is Inhibit. The adjustable range is 0.0-100.0%.

(5) Switch setting

The switch will display the current switch position. Press UP or DN to select the desired item, press ENT to the setting interface and “0” before the item will be changed into “1”. If two or more items are selected, the item And should be selected. Press EXT to exit after finished.

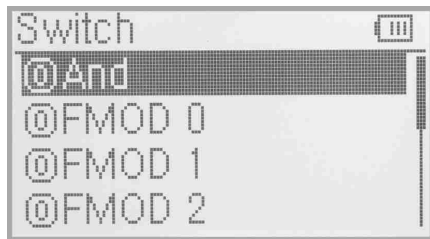

3.13 Rudder to aileron/elevator mix

This function is used to execute the mix of rudder to aileron/elevator .It will help eliminate waver or shake caused by rudder stick operation.

Setting method:

Press ENT to enter Main Menu in the main interface,and press UP or DN to make the navigation mark to choose "Function Menu".Press ENT to enter "Function Menu",then press UP or DN to choose "Rudder to aileron/elevator mix" and press ENT to enter "Rudder to aileron/elevator mix" setting interface.

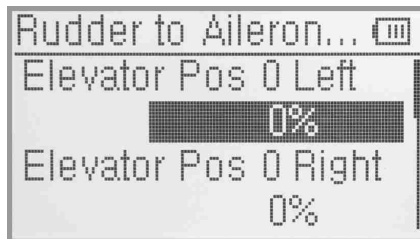

(1) Elevator setting

(1.1) Elevator Pos 0 Leftward setting

Press UP or DN to make the navigation mark choose "Elevator Pos 0 Leftward setting"item,and press R or L to change the value and the Elevator mix amount when operating Rudder leftward .The mix direction will be revised by changing the sign of plus or minus before the value.The adjustable range is $\pm 125\%$.

(1.2) Elevator Pos 0 Rightward setting

Press UP or DN to make the navigation mark choose "Elevator Pos 0 Rightward setting"item,and press R or L to change the value and the Elevator mix amount when operating Rudder rightward .The mix direction will be revised by changing the sign of plus or minus before the value.The adjustable range is $\pm 125\%$.

(1.3) Elevator Pos 1 setting:refer to "1.1 Elevator Pos 0"setting.

(2) Aileron setting

(2.1) Pos 0 setting: refer to "1.1 Elevator Pos 0"setting.

(2.2) Pos 1 setting: refer to "1.1 Elevator Pos 0"setting.

(3) Throttle stick setting

The switch between Pos 0 and Pos 1 can be realized by the position of Throttle Stick,then press R or L to change the value or Inhibit.Change the value to set the Thottle Stick position.The default setting is "Inhibit",the adjustable range is from 0.0 to 100.0%.

(4) Switch setting

Switch item will display the current Switch position.Press UP or DN to make the navigation mark choose "Switch"item,and ENT to enter the selectable switch interface,press UP or DN to make the navigation mark choose the desired Switch .Press ENT to confirm and change the left sign from "0" into "1".If two or more items are selected,the item And should be selected and then the left sign "0" will be changed into "1". Press EXT to exit after finished.

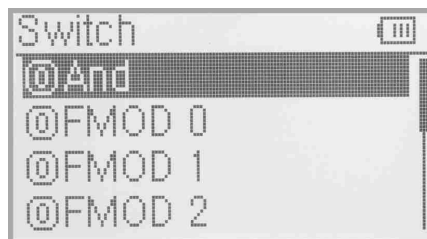

3.14 Flap System

This function can modify some effects on elevator.It is possible to set 3 status of elevator and 3 status of flap system,respectively,through 3-way flap control switch.

Setting method:press ENT to enter Main Menu in the main interface,then press UP or DN to make the navigation mark choose "Function Menu",.press ENT to enter Function Menu.Press UP or DN to choose "Flap System" and then ENT to enter its setting interface.

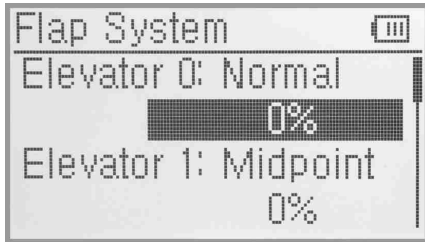

(1) Elevator setting

There are 3 options:0:Normal;1:Midpoint and 2:Land.

(1.1) Elevator 0:Normal position

press UP or DN to make the navigation mark choose "Elevator 0:Normal",and press R or L to change the elevator mix amount.It is possible to change the direction by altering U or D before the amount.The default setting is 0%,and the adjustable range is U125% - D125%.

(1.2) Midpoint position:Please refer to "1.1 Elevator 0:Normal"setting

(1.3) Land position: Please refer to "1.1 Elevator 0:Normal"setting

(2) Flap setting:the setting for flap is same as elevator.

(3) Status

Press UP or DN to make the navigation mark choose "Status",then vibrating the flap switch(refer to 2.9 Device select) will display current position

(4) Auto land

(4.1) Throttle stick setting

Press UP or DN to make the navigation mark choose"Throttle stick"item,and press R or L to change value or Inhibit.It is possible to set the position when changing the value.The default setting is "Inhibit",and adjustable range is from 0.0 to 100.0%.

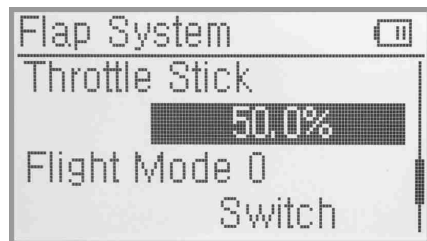
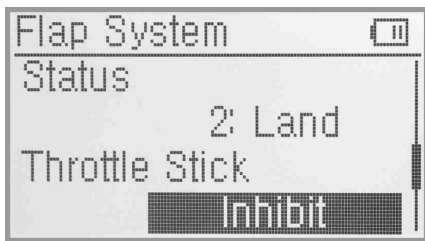

(4.2) Flight mode 0 setting

It is possible to set a certain flight mode switch automatically after automatic land.When do this ,you must come to "Wing type" setting interface under the Model Menu and make correspond Wing type setting.Refer to 2.11 Wing type.

Press UP or DN to make the navigation mark choose "Flight mode 0"item,and press R or L to 3 options : 0:Normal;1: Midpoint and 2:Land.It is Mannul control when choose "Switch",but Automatic control when choose Flight mode switch position.

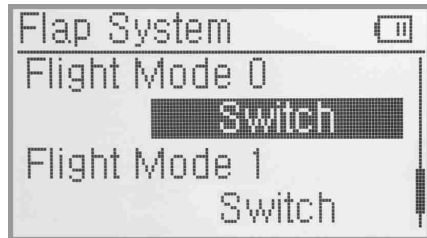

(4.3) Flight mode 1 setting:refer to "(4.2)Flight mode 0 setting"

(4.4) Flight mode 2 setting: refer to "(4.2)Flight mode 0 setting"

Press EXT to exit after finished.

3.15 Aileron to flap mix

The function aims at mixing flap when operating aileron stick, and can set switch. The flap dual channels should also be previously activated at Wing Type in Mode Menu(refer to"2.11 Wing Type")

Setting method

Press"ENT" to enter into"main menu"; press UP or DN to make navigation mark select "function menu", press"ENT"to enter into"function menu"; press UP or DN to select "Aileron to flap mix", press"ENT" to "Aileron to flap mix"designed interface.

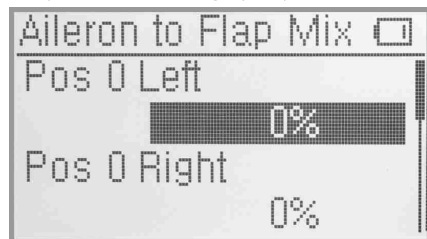

(1) Pos 0 to leftward setting

Press UP or DN to make navigation mark select "Pos 0 to leftward setting",press R or L to change the leftward mix value of aileron to flap,the mix direction will be revised by changing the sign of plus or minus before the value,the adjustable range is $\pm 125\%$.

(2) Pos 0 to rightward setting

press UP or DN to make navigation mark select "Pos 0 to rightward setting",press R or L to change the rightward mix value of ailren to flap,the mix direction will be revised by changing the sign of plus or minus before the value,the adjustable range is $\pm 125\%$.

(3) Pos 0 to leftward setting: refer above "(1) pos 0 to left setting"

(4) Pos 0 to rightward setting: refer above"(2) pos 0 to right setting"

(5) Throttle stick setting

The switch between Pos 0 and Pos 1 can be realized by setting the position of throttle stick. Press UP or DN to make navigation mark select "throttle stick setting", press R or L to change the value or inhibit. Change value can set throttle stick postion.The default setting is "inhibit". The adjustable range is from 0.0% to 100.0%

(6) Switch setting

Press UP or DN to make navigation mark select "switch" setting, press ENT to enter into usable switch interface, press UP or DN to make navigation mark select desired switch setting.Press ENT to confirm,make left sign from "0" to "1". If two or more items are selectable,the item And should be selected,to make left sign from "0" to "1", Press EXT to exit after finished.

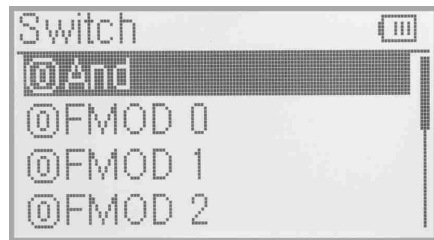

3.16 Program mix

There are total eight sets of Program Mix, It is possible to freely set th channels and amounts which you want to select and amend,respectively.

Setting method:

press "ENT" enter to "main menu"; press UP or DN to make navigation mark select "function menu", press "ENT" to enter into "function menu"; press UP or DN to select "program mix", press"ENT" enter into"program mix", shown "program mix 1" and settable status(the factory default setting is Inhibit).Take program Mix 1 as an example.

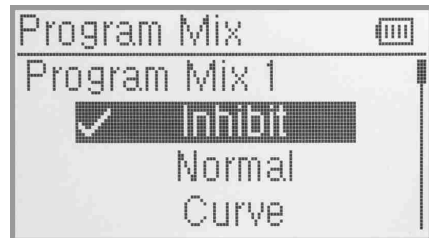

(1) Setting method for Normal in Program Mix.

Press UP or DN to make the navigation mark choose "Normal" item,and press ENT then expands up an enquiry "All Servos Hold?".Choose "OK" for all the servos will be locked at the current statuses;choose "Cancel" for unlocked.Enter the next interface after choosing.

(1.1) Master Channel setting

Press UP or DN to make the navigation mark choose "Master Channel" item,and press ENT to enter the Master Channel setting interface.Press UP or DN to choose the desired channel,then press ENT to confirm the mark "√" before choosed channel name,press ENT to return the Program Mix 1 interface.

(1.2) Slave Channel setting

Press UP or DN to make the navigation mark choose "Slave Channel " item, and press ENT to enter the Slave Channel setting interface.Press UP or DN to choose the desired channel ,and press ENT to confirm the mark "√"before the Slave Channel ,and "EXT" to return Program Mix 1 interface.



(1.1) Master Channel setting

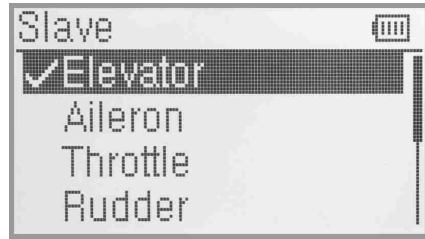

(1.2) Slave Channel setting

(1.3) Gain setting:take Elevator at Master Channel as an example.

(1.3.1) Position 0 upward

Mix amount setting when elevator stick moved upward. Press UP or DN to make the navigation mark choose "position 0 upward" item, and press R or L can increase/decrease Mix amount. It is possible to reverse mix direction through changing the plus or minus sign before amount. The adjustable range is $\pm 125\%$.

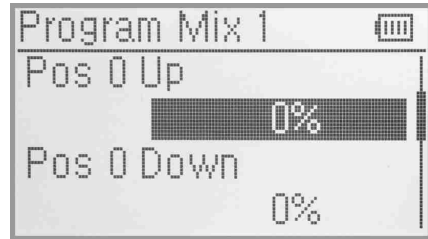

(1.3.2) Position 0 downward

Mix amount setting when elevator stick moved downward. Press UP or DN to make the navigation mark choose "position 0 downward" item, and press R or L can increase/decrease Mix amount. It is possible to reverse mix direction through changing the plus or minus sign before amount. The adjustable range is $\pm 125\%$.

(1.3.3) Position one upward/downward setting method refer to (1.3.1) position zero upward setting .

(1.3.4) Offset setting

This function can make Slave begin to mix through the corresponding Lever switch from a certain point as the starting point. Press UP or DN to make the navigation mark choose "Offset", press R/L to increase or decrease the mix amount. It is possible to reverse the offset direction through changing the plus or minus sign before amount. The adjustable range is $\pm 100\%$.

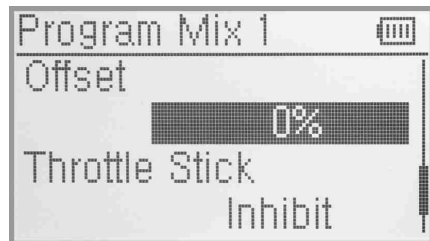

(1.4) Throtte Stick

Press "UP" or "DN" to select "throttle stick setting". Press "R" or "L" to change the data for setting its position amount or Inhibit. The default setting is Inhibit. The adjustable range is 0.0-100.0%.

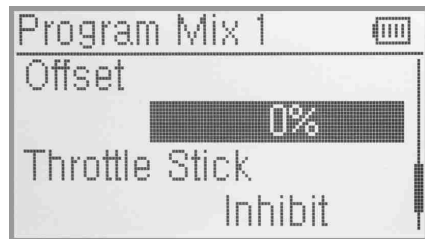
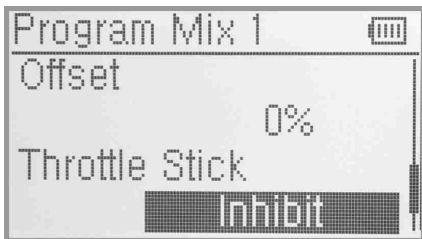

(1.5) Switch Selection

Press UP or DN to make navigation mark select "switch" setting, prss ENT enter into useable switch interface, press UP or DN to make navigation mark select desired switch setting. Press ENT to confirm, make left sign from "0" to "1". If two or more items are selectable, the item And should be selected, to make left sign from "0" to "1", Press EXT to exit after finished.

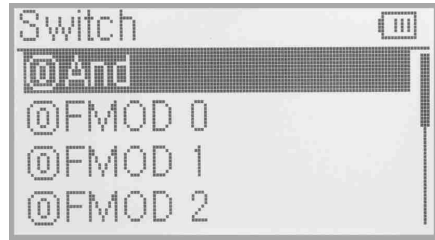

(2) Setting Method for Curve in Program Mix1

Press the item Curve in Program Mix 1 and expands an enquiry “All Servos Hold?” Click OK for all the servos will be locked at the current states; click Cancel for unlocked. Enter the next interface after clicking. Press ENT key to enter the setting interface of Program Mix1.The interface will show the setting items and curve table.

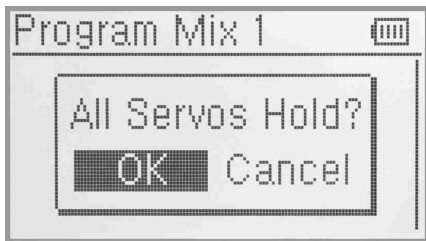

(2.1) Master Channel setting

Press UP or DN to move the navigation mark to “Master Channel”item,and press ENT to enter the Master Channel setting interface.Press UP or DN to choose the desired channel,then press ENT to confirm the mark “√” before choosed channel name,press ENT to return the Program Mix 1 interface.

(2.2) Slave Channel setting

Press UP or DN to move the navigation mark to “Slave Channel ”item,and press ENT to enter the Slave Channel setting interface.Press UP or DN to choose the desired channel ,and press ENT to confirm the mark “√”before the Slave Channel ,and “EXT” to return Program Mix 1 interface.

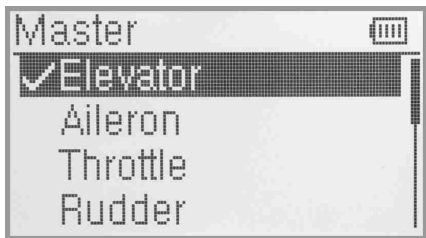

(2.1) Master Channel setting

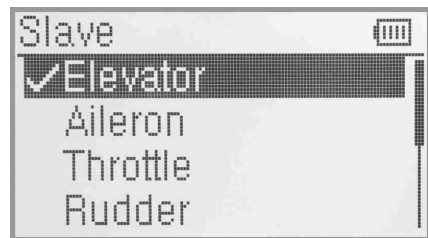

(2.2) Slave Channel setting

(2.3) Position

There have two options:Pos 0 and Pos 1.Press “UP” or “DN”to select the desired position.

(2.4) Exponential

Press“UP”or “DN”to enter “Exponential”, and Press“R” or “L” to expand a dropdown menu with two options of Off and On. The pitch curve will be smoothly changed if choosing On.Otherwise choosing Off.



(2.3) Position

(2.5) Point Setting

Press UP or DN to move the navigation mark of Point option. Press R or L, there are 7 point options including Point-L, Point-1, Point-2, Point-M, Point-3, Point-4 and Point-H. Select the point you want to set.

(2.6) Status setting

(There is no Status options when the point is Point-L or Point-H). After selecting the point that you want to set, press UP or DN to move the navigational mark to Status item. Press R or L, there are two options of Inhibit and Active. Select Inhibit for unchanging the current amount (the default setting is Inhibit).



(2.5) Point Setting

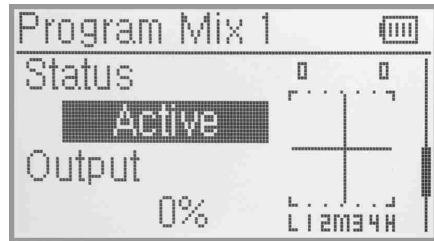

(2.6) Status setting

(2.7) Output

When the Status option is Active, the Output option will be listed. Press UP or DN to move the navigational mark to Output. Press R or L to increase or decrease, respectively, the output amount. It is possible to reverse the mix direction by changing the plus or minus sign before the amount. The adjustable range is $\pm 100\%$.

(2.8) Throttle Stick Setting

Press "UP" or "DN" to select "throttle stick setting". Press "R" or "L" to change the data for setting its position amount or Inhibit. The default setting is Inhibit. The adjustable range is 0.0-100.0%.



(2.9) Switch Selection

Press UP or DN to make navigation mark select "switch" setting, press ENT enter into useable switch interface, press UP or DN to make navigation mark select desired switch setting. Press ENT to confirm, make left sign from "0" to "1". If two or more items are selectable, the item And should be selected, to make left sign from "0" to "1", Press EXT to exit after finished.

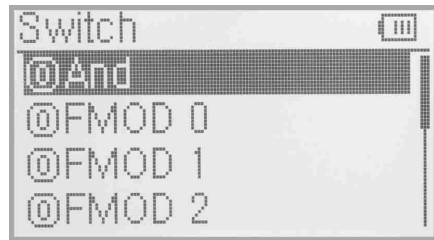

Press "EXT" to return to the interface of Program Mix for other setting. Or Press "EXT" once again to exit.

3.17 Monitor

This function can display the current statuses and positions of all the channels' outputs, and check the current working status of each channel.

Press ENT to enter Main Menu, and then press UP or DN to move the navigational mark to select Function Menu. Press ENT to enter the Function Menu and then press UP or DN to select servo Monitor and press ENT to enter the monitor interface for checking the current working status of each channel. Press EXT to exit .

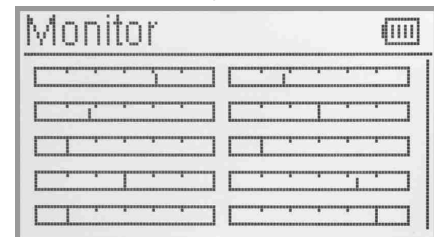

3.18 Fail safe

There are two possibilities for use if the transmission signal is under abnormal condition. The first one is to lock the last action data received; the second one is to execute the pre-set data which is pre-set. The default setting is Servo Hold.

Setting method:

Press ENT to enter the Main Menu, and then press UP or DN to move the navigational mark to select Function Menu. Press ENT to enter the Function Menu then press UP or DN to select Fail Safe and press ENT to enter the Fail Safe interface. Take the item Elevator as an example to explain.



Press UP or DN to select Elevator on the Fail Safe interface, then press R or L to change the status of Servo Hold into Fail Safe (If you want to keep Servo hold status, there is no need to re-set). There is an expanded sub-item below. Press UP or DN to select 0%, then press R or L to increase or decrease, respectively, the position amount which centers on the neutral point of servo. The available value is 125%, respectively. 0% is the neutral point of servo.



The setting methods for other channels are same as above. Press EXT to exit after finished.

Note: checking whether all the actions when fail safe happened are correct, is a must after the setting is finished. It is dangerous to use full throttle, especially after fail safe taken place.

3.19 Sensor View

Setting method: Press ENT to enter the Main Menu and press UP or DN to move the navigational mark to select Function Menu. Then press ENT to enter the Function Menu and press UP or DN to select Sensor View, then press ENT to enter the Sensor View interface, like below pictures. If all the sensors disconnect, telemetry signal lost, there will be inhibits shown on the view. If all work normal, all the measured data will be shown.

(1) Voltage: Show 3 different measured voltage value;

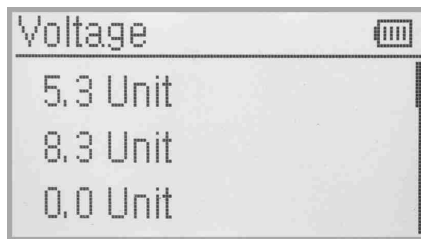

(2) Temperature: Show 4 different measured temperature value;

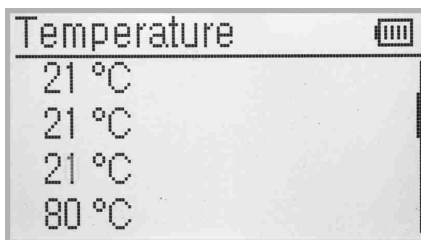
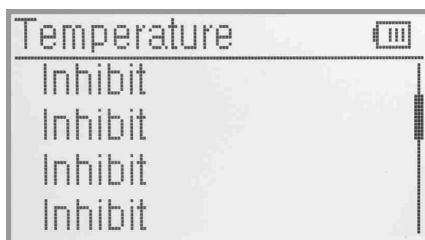

(3) Rate Sensor: Show 2 different measured RPM value;



(4) GPS Sensor: Press UP or DN to turn to GPS function, show located date, time, longitude, latitude, altitude and speed;

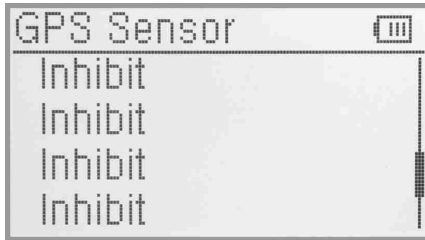

3.20 Trainer

Two DEVO-10 transmitters working together can execute the training function to meet the requirements for the beginner. The setting method is shown as below:

(1) Data copy

First, use the wireless copy function between two DEVO-10 to copy the main transmitter's model data to the trainee's transmitter, this promise the the model data between two transmitters is same. Refer the copy method to the second part of helicopter "2.4 model wireless copy" and do the following steps:

(2) Linkage

Insert the signal wire from the trainer's transmitter into the DSC socket of the trainee's transmitter. Turn on the transmitter and a linkage icon will be shown on the boot screen.

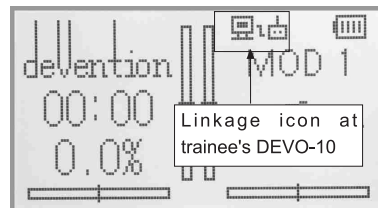

linkage icon

Turn on the power of the trainer's radio. Find out the trainee's model data, and then let the trainer's Radio bind with the aircraft model and fly it normally. Then turn off the power. Insert the other end of the digital signal wire into the trainer's DEVO-10, and then turn on its power. A linkage icon will be shown as below:

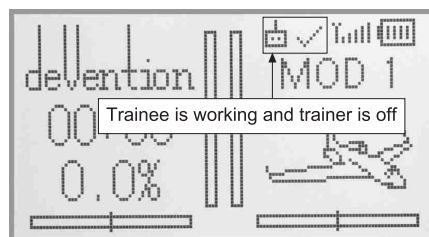
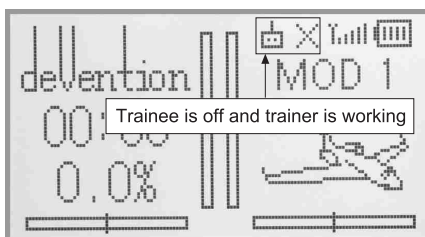

Trainer icon

Training status display: when the trainer’s icon becomes into “X”, the trainee stops flying and the trainer is working; when the trainer’s icon turns into “√”, the trainee is flying and the trainer is in leisure.

(3) Usage method

The training switch can be freely switchable between Left trim and Right trim. The default setting is Right trim. Shown as below:



During flight, if the trainer pushes Right Trim once, the linkage icon will be shown as “√” that means the control right is moved to the trainee from Trainer. If trainer pushes Right Trim once again, the linkage icon will be shown as “X” that means the trainer takes back the control right from the trainee.

(4) Setting for training function channels

Trainee is available to get full or part of flight control power to the aircraft model via setting the training function channel in the trainer’s radio. Below is the setting method:

Push the ENT button to enter main Menu, and then push UP or DN to get access to function menu. Then push UP or DN to select “training function” and push ENT button to enter Trainer screen interface. The available channels are shown below, and the current status of trainer switch is also shown there.

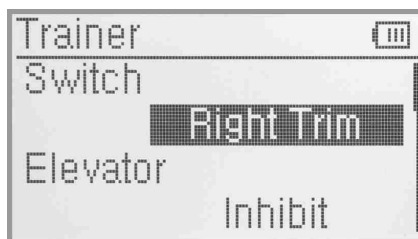

Trainer switch selection: Press UP or DN to select the switch option; press R or L to select the switch which you want. It includes right and left trim. The default setting is Right trim.

Channel selection: Press UP or DN to select the channel option; Press R or L to select the channel(s) which you want to grant to trainee. The channel(s) you have selected will be activated as “Active”. The channels which are not granted to trainee will be kept inhibited. The default setting is “Inhibit”.

Press EXT to exit.

3.21 Timer

There are two timers which can be set as stopwatch and countdown, respectively. Each timer can be operated by switch or by shortcut.

Setting method:

Press ENT to enter Main Menu, and then press UP or DN to get access to Function Menu. Then push UP or DN to select “Timer” and press ENT to enter Timer interface. The timing range of stopwatch is from 0 to 59:59 (59 minutes 59 seconds). The default setting is stopwatch.

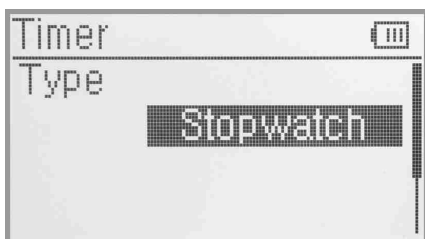

(1) Countdown setting

If you need countdown time manner,press R or L to select the countdown.There is an expand sub-menu set time item.Press UP or DN to move the navigational mark to select the option of Setting time item. Press R or L to set the countdown time.The settable countdown time range is from 00:05 to 59:55.



(2) Switch selection

Press UP or DN to move the navigational mark to Switch.There are Inhibit and available switch options, available switch can be selected by press L or R. It includes FMOD1,2, FMOD2, MIX1,2, MIX2, ELEV D/R,AILE D/R, RUDD D/R, GEAR SW, SPS0 SW, SPS1 SW, SPS2 SW and SPS3 SW. We can select the desired item except these items of SPS0 SW, SPS1 SW, SPS2, and SPS3 which should be previously set at Stick Position Switch at Model Menu(refer to “2.8 Stick Position Switch”).

Press EXT to exit after finished.

(3) Usage of timer

Press UP or DN in main panela. It's possible to start Timers by pressing UP key for one time, and to pause it by pressing it the second time. Press DN to clear timer. It's ok to control time by Switch when time setting is finished on switch. Timer will be shown in main interface, as below illustration:

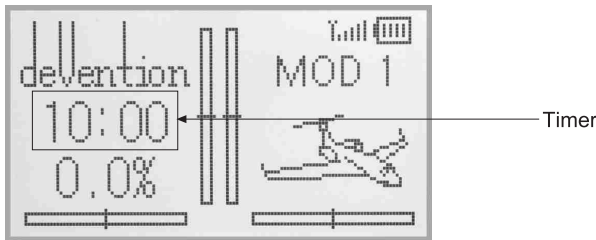

4.0 Upgrading

Software can be upgraded in PC via downloading or uploading the configuration files.

Enter upgrading interface: Press EXT and power on the radio when the radio is in powered off status, below illustration will show as below.



The operation guide for connecting to PC upgrading should be mentioned with upgrading software.



This symbol indicating separate collection for electrical and electronic equipment.



Add.: Taishi Industrial Park, Dongchong Town
Panyu District, 511475 Guangzhou

Tel.: (8620) 8491 5115 8491 5116

Fax.: (8620) 8491 5117

Web: www.walkera.com

Email: heli@walkera.com
info@walkera.com

The specifications of the R/C Product
may be altered without notice.

