



HISKY®

X-6S

Instruction Manual

2.4GHz FHSS
Frequency Hopping Spread Spectrum

HISKY®



DIGITAL PROPORTIONAL R/C SYSTEM **X-6S**

Table of Contents

Caution	2
1.1 Transmitter Chart	3
1.2 2.4GHz Binding	4
1.3 Basic features	4
1.4 Main function Interface	4
1.5 LED displaying board function	5
1.6 Menu	6
2.1 System menu introduction	7
2.2 Model set	8
2.3 Plane type	10
2.4 Stick mode	10
2.5 Stick adj	11
2.6 Trainer	11
2.7 Timer set	12
3.1 Function menu introduction(Heli)	13
3.2 D/R	15
3.3 SUB Trim	16
3.4 Travel	17
3.5 CH.Rev	17
3.6 Swash.Mix	18
3.7 GYRO.Sens	18
3.8 Thro.Curve	19
3.9 Monitor	19
3.10 Pit.Curve	20
3.11 Thro.Hold	20
4.1 Function menu for fixed wing plane	21
4.2 V-Tail function menu	21
4.3 Delta mix function menu	22
5.1 Heli.Connection Diagram(3Servos CCPM)	22
5.2 Airplane Connection Diagram	23
5.3 V-Tail Connection Diagram	24
5.4 DELTA-MIX Connection Diagram	24
Technology Data	25

Caution

- ✍ To work your R/C with your models correctly and safely, read this manual carefully and keep it in a safe way as a reference introduction in the future.
- ✍ Warning:
 1. This product is only equipped for radio controlled models;
 2. The usage of this product should be approved by local relevant law or regulations;
 3. We will not be responsible for the damages caused by unauthorized modification, adjustment or replacement of parts of this product;
 4. The manual may be altered without prior notice. Please contact us if you have any corrections or clarifications that should be made in the manual.
- ✍ Please pay more attention to the parts in this manual, which are marked with "Warning".
- ✍ Because of interference, do not work your radio control system simultaneously with others at the same frequency.
- ✍ Before starting the transmitter, make sure the transmitter batteries are well loaded. The voltage of transmitter batteries is never lower than 8.6V. And please check and confirm that the servos are all well and properly connected.
- ✍ Please remove batteries from transmitter after flying and during the transportation.
- ✍ Please check and have a test on control surfaces to confirm the transmitter handling of each part prior to each takeoff. The frequencies of the module and the receiver should be the same.
- ✍ Keep the radio system away from moist, high temperature and strong shake. Do not clean the product with solvent.
- ✍ Do not fly your models near airfield, schools, hospitals, residences, power transmission network, communication facilities and other places that are forbidden for starting the transmitter. Please stop flying your models with the radio on rainy or windy days.
- ✍ Do not fly the models when you are tired, sick, intoxicated, or not in good spirit.
- ✍ Ensure the antenna does not touch anything else when power switch is turned on.
- ✍ Do not leave this product and its accessories within the reach of small children.
- ✍ Always ensure the antenna screw is tightened.
- ✍ Please use this product according to your local relevant law or regulation, we are not responsible for any incidents or damages.

1.1 Transmitter Chart

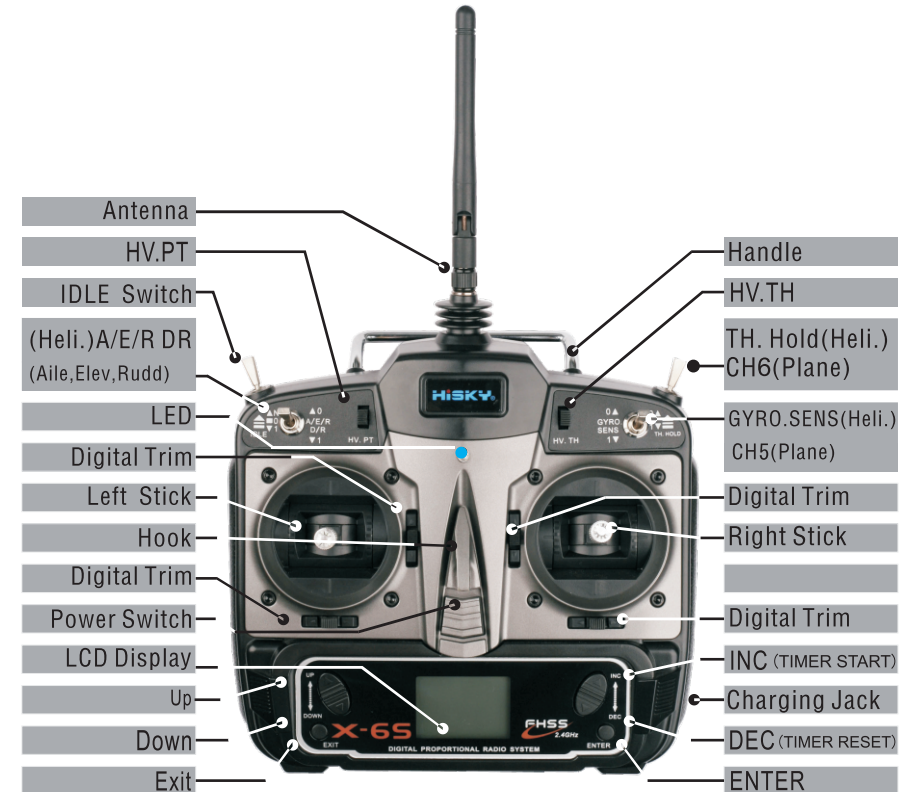

1.2 2.4GHz Binding

1. The Binding processing

Turn on the transmitter, then connect the power of receiver by pressing the receiver "BIND" button till the light turn on GREEN which means the binding is successful.

Caution: make sure the RX and TX is within one meter, and around 10 meters no similar device.

If the light flashes, it means the binding failed, please repeat above steps.



1.3 Basic features

1. Pitch neutral trim;
2. Output standard 6 channel signal and support 2.4G System.
3. Support 3D fly mode: normal fly, idle 1 fly and idle 2 fly (In the idle mode)
4. D/R for Aileron, elevator, rudder ;
5. Throttle hold function;
6. Gyro sensitivity adjustment;
7. Channel neutral position setting
8. Channel reverse and channel servo travel adjustment;
9. Six models data memory;
10. POWER LED will blink with alarm when the voltage is below 4.0v.

1.4 Main function Interface

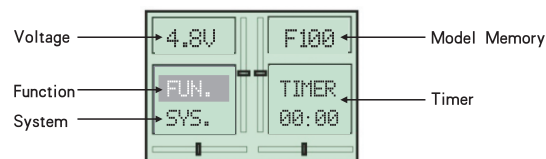

1.5 LED displaying board function

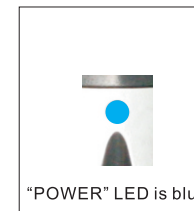

"POWER" LED

The light keeps on with blue color in normal power-on condition.

When the voltage is below 4.0v, the light blinks with alarming. Now please exit the operation and change new battery

Note

If "HOLD ON" is shown on LCD when you turn on the power, please move "TH HOLD" switch to the position 0, otherwise, you can not properly enter power on interface.

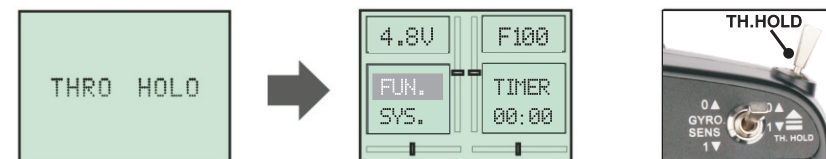

Note

If "IDLE ON" is shown on LCD when you turn on the power, please move "IDLE" switch to the position N, otherwise, you can not properly enter power on interface.

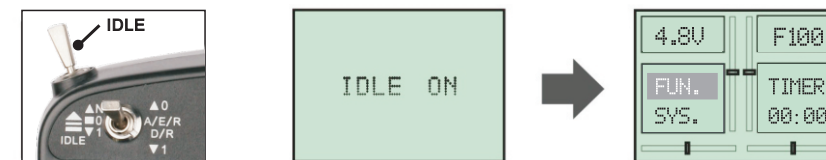

1.6 Menu

FUN. MENU

HELI.	Plane	V-Tail	Delta
D/R	D/R	D/R	D/R
SUB.TRIM	SUB.TRIM	SUB.TRIM	SUB.TRIM
TRAVEL	TRAVEL	TRAVEL	TRAVEL
CH.REV	CH.REV	CH.REV	CH.REV
SMASH.MIX	MONITOR	MONITOR	MONITOR
GYRO.SEN		V-TAIL	DELTA-MIX
THRO.CURV			
MONITOR			
PIT.CURV			
THRO.HOLD			

SYS. MENU

HELI.	Plane	V-Tail	Delta
MODEL.SET	MODEL.SET	MODEL.SET	MODEL.SET
PLANETYPE	PLANETYPE	PLANETYPE	PLANETYPE
STICKMODE	STICKMODE	STICKMODE	STICKMODE
STICK ADJ	STICK ADJ	STICK ADJ	STICK ADJ
TRAINER	TRAINER	TRAINER	TRAINER

- 1.MODEL SET-- Here you can set the parameter of the model, rename, save and format to recover to the factory setting.
- 2.PLANE TYPE--Four types of plane are selectable. Helicopter, fixed wing(plane), V-Tail and Delta.
- 3.STICK MODE--Operating stick selection: Mode 1 (right throttle), Mode 2 (left throttle), Mode 3 and Mode 4.
- 4.STICK ADJ--Neutral position setting of 4 proportional channels controlled by the operating stick.
- 5.TRAINER--This menu can be used for simulation software setting.

2.1 System menu introduction

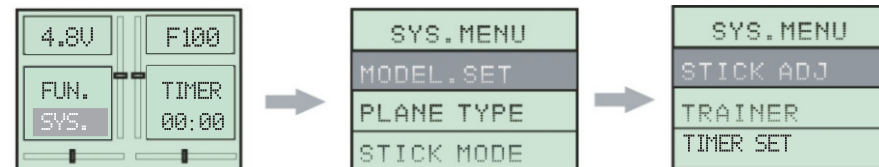

MODEL SET (Page8--9)

MODEL	MOD0	RENAME	A0D0	MODEL	MOD0	MODEL	MOD0
RENAME		0123456789		SAVE TO: MOD1		RECOVER..	
SAVE AS		ABCDEFGHIJ		RECOVER		RECOVER	
RECOVER		KLMNOPQRST					
		UVWXYZ	←→				

PLANE TYPE (Page10)

SYS. MENU
MODULATE
HELIC PLANE
V-TAIL DELTA
PLANE TYPE

STICK MODE (Page10)

STICK MODE	STICK MODE	STICK MODE	STICK MODE
MODE 1	MODE 2	MODE 3	MODE 4
RU AI TH	RU AI TH	AI RU TH	AI RU TH
EL TH	TH EL	EL TH	TH EL

STICK ADJ (Page11)

SYS. MENU	SYS. MENU
adjust?	Adjust
CH NO	CH
TRAINER	TRAINER

TRAINER (Page11)

SYS. MENU	SYS. MENU
TRAINER	TRAINER
NORMAL	TRAINER
TRAINER	TRAINER

2.2 Model set

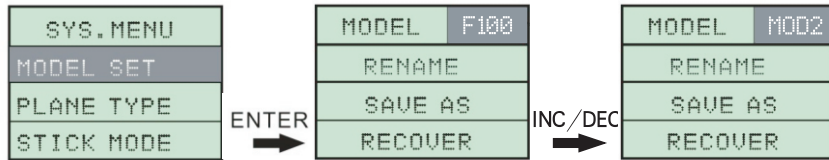

Calling model number

Operation:

- 1) Press “down” to select “SYS MENU” ,and press “ENTER” to come to the interface.
- 2) Once again press “ENTER” to come to “MODEL SET” interface,and now the shadow area is the item that can be set currently.
- 3) Press “up” or “down” to select mode you expect. The default setting are Mod1,Mod2, Mod3,Mod4,Mod5,Mod6.
- 4) Press “ENTER” to confirm when a model number is selected. otherwise your selection is invalid.

Remark:when your selection is successful, the model naming area in the main interface will show the corresponding change.

Please note:All your settings have been saved in the current model number.

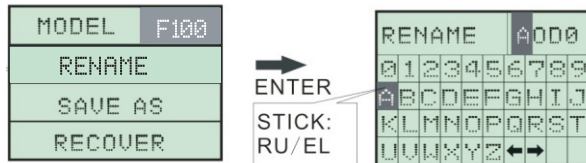

Rename model number

Operation:

- 1) Press “down” to select “SYS MENU” ,and press “ENTER” to come to the interface.
- 2) Once again press “ENTER” to come to “MODEL SET” interface,and now the shadow area is the item that can be set currently.
- 3) Press “up” or “down” to select the setting function items, and press “ENTER” to come to “RENAME” .
- 4) Move the stick in EL/RU four directions to select letters or digits to rename your item. Press “ENTER” to confirm when letters or digits are selected,otherwise your selection is invalid.

Caution:when cannot select letters to the left need redone “STICK ADJ” .

Remark:when the cursor is at ‘ ← or → ’ ,press “ENTER” to quickly change the single letter of the name.

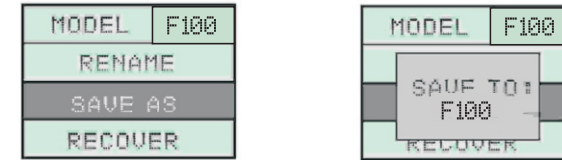

“ENTER”

Save as model number

Operation:

- 1) Press “down” to select “SYS MENU” ,and press “ENTER” to come to the interface.
- 2) Once again press “ENTER” to come to “MODEL SET” interface,and now the shadow area is the item that can be set currently.
- 3) Press “up” or “down” to select the setting item, and press “ENTER” to come to “SAVE AS” .
- 4) Press “up” or “down” to select your model number to be saved . Press “ENTER” to confirm when the number is selected. It can be saved again and again in different model number groups. Press “EXIT” to leave the setting.

Remark:the data of the current model number group will overlay another data group,so please be careful.



“ENTER”

Recover the factory data

Operation:

- 1) Press “down” to select “SYS MENU” ,and press “ENTER” to come to the interface.
- 2) Once again press “ENTER” to come to “MODEL SET” interface,and now the shadow area is the item that can be set currently.
- 3) Press “up” or “down” to select the setting item, and press “ENTER” to come to “RECOVER” .
- 4) Press “ENTER” to recover the factory setting . and press “EXIT” to leave the menu.

Remark:This recovery will clear the data of the current model number,please be careful.

2.3 Plane type

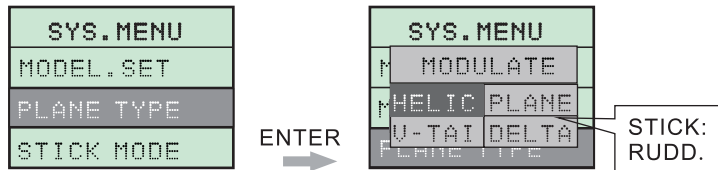

✍ Plane type selection

Operation:

- 1) Press “down” to select “SYS MENU” ,and press “ENTER” to come to the interface.
- 2) Press “up” or “down” to select “PLANE TYPE” ,and now the shadow area is the item that can be set currently.Press “ENTER” to go to the next step.
- 3) Now comes out a dialing box,Press “up” or “down” to select ' HELIC ', ' PLANE ', ' V-TAIL ' or ' DELTA '. And press “ENTER” to save the setting and leave the operation.

2.4 Stick mode

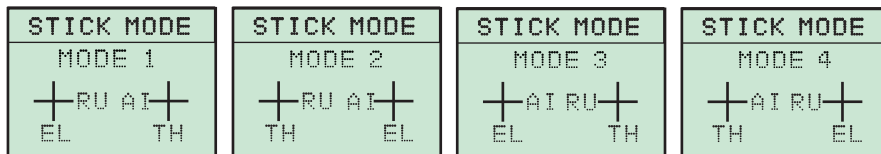

✍ Stick mode selection

Operation:

- 1) Press “down” to select “SYS MENU” ,and press “ENTER” to come to the interface.
- 2) Press “up” or “down” to select “STICK MODE” ,and now the shadow area is the item that can be set currently.Press “ENTER” to go to the next step.
- 3) Press “up” or “down” to select ‘MODE1’ (right throttle), ‘MODE2’ (left throttle), ‘MODE3’ , ‘MODE4’ .And press “ENTER” to save the selection and press “EXIT” to leave the operation.

Remark:This operation changes the distribution of 4 proportional channels Please note: 'AILE', 'ELEV', 'THRO', 'RUDD' channels have been distributed now.

When the stick mode is changed,the menu order controlled by the stick 'AI' and 'EL' is also changed.Please pay attention to the difference.

2.5 Stick adj

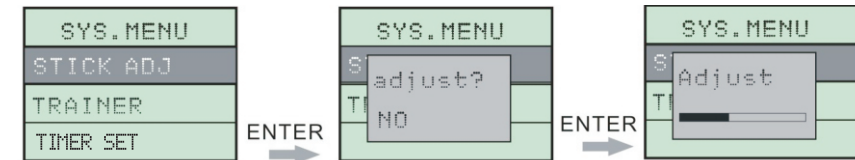

✍ Stick neutral position setting

Operation

- 1) Once again press “ENTER” to come to “STICK ADJ” interface, and now the shadow area is the item that can be set currently.
- 2) Before your operation, please be sure that the 4 proportional channels of the sticks are in the neutral position, and the 4 electronic trim buttons are also in the neutral position
- 3) Press “ENTER” to enter, and now comes out a dialing box. Press “up” or “down” to select “NO” or “YES” , and press “ENTER” is ok! When you hear one 'beep' sound, the neutral setting is successful.
- 4) Press “EXIT” to save and leave the setting.

2.6 Trainer

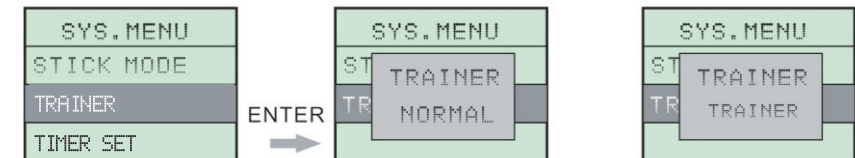

✍ Trainer mode selection

Operation

- 1) Press “down” to select “SYS MENU” ,and press “ENTER” to come to the interface.
- 2) Press “up” or “down” to select “NORMAL” or “TRAINER” .

NORMAL--normal fly

TRAINER--simulating software fly

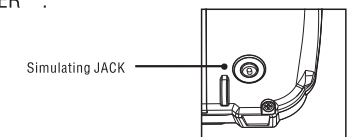

NOTE

1. This function is also for simulation fly in the computer. But this simulation fly should go with a special cable and simulating soft ware.
2. please do not connect “Trainer” interface at the back of the transmitter to any electric equipment or other radio transmitters, or else, we are not responsible for any damages.
3. This interface does not support training function, it is only for flying simulation software.

2.7 Timer set

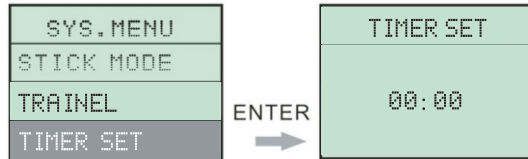

✍ Choose Timer set

Operation

1. Press Down to select Sys Menu, and press Enter to the interface
2. Down button select Timer SET
3. Up and Down button setting time M:S
4. Entering setting Timer Press INC or DEC choosing increase and decrease
5. Return main Interface. INC -- TIMER START DEC -- TIMER RESET

Caution: This setting before and after 20 seconds each two seconds Alarm. after Alarming each 10 seconds. then Alarm not stop.
Press DEC --- TIMER RESET LOGOUT TIME RENEW TIMER

3.1 Function menu introduction(Heli)

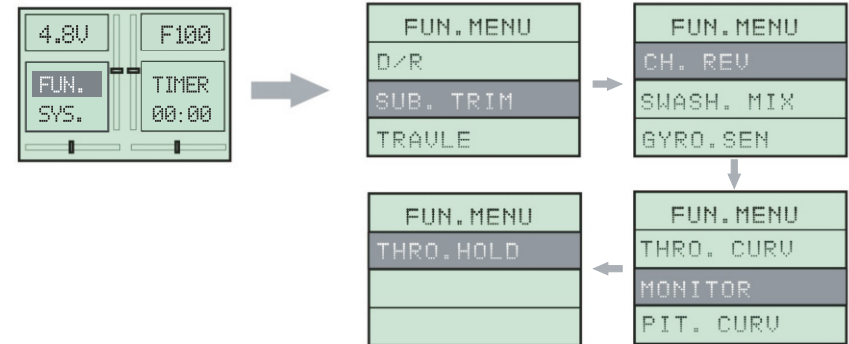

DR	AILE0	DR	AILE0	DR	AILE1
E 0		E 0		E 0	
R 100		R 100		R 100	
I 0		I 0		I 0	
O 0		O 0		O 0	

DR (Page 15)

SUB. TRIM		SUB. TRIM	
AILE	0	RUDD	0
ELEV	0	GEAR	0
THRO	0	PITH	0

SUB TRIM (Page 16)

TRAVEL		TRAVEL	
AILE	100	RUDD	100
ELEV	100	GEAR	100
THRO	100	PITH	100

TRAVEL (Page 17)

REV. SW						
CH	1	2	3	4	5	6
REV	█					
NOR	█	█	█	█	█	█

CH.REV (Page 17)

SWASH. MIX		SWASH MIX (Page 18)
AILE	-50	
PITH	-50	
ELEV	-50	

GYRO. SENS		GYRO. SENS (Page 18)
POS0	-100	
POS1	100	

<table border="1" style="width: 100%; border-collapse: collapse;"> <tr> <td colspan="2" style="text-align: center;">THRO. CURV</td> <td style="text-align: right;">THRO. CURV (Page 19)</td> </tr> <tr> <td>NOR</td> <td></td> <td></td> </tr> <tr> <td>I</td> <td style="text-align: center;">50</td> <td></td> </tr> <tr> <td>O</td> <td style="text-align: center;">50</td> <td></td> </tr> <tr> <td>L</td> <td style="text-align: center;">75</td> <td></td> </tr> </table>	THRO. CURV		THRO. CURV (Page 19)	NOR			I	50		O	50		L	75		<table border="1" style="width: 100%; border-collapse: collapse;"> <tr> <td colspan="2" style="text-align: center;">THRO. CURV</td> <td style="text-align: right;">THRO. CURV (Page 19)</td> </tr> <tr> <td>IDLE 0</td> <td></td> <td></td> </tr> <tr> <td>I</td> <td style="text-align: center;">20</td> <td></td> </tr> <tr> <td>O</td> <td style="text-align: center;">20</td> <td></td> </tr> <tr> <td>H</td> <td style="text-align: center;">75</td> <td></td> </tr> </table>	THRO. CURV		THRO. CURV (Page 19)	IDLE 0			I	20		O	20		H	75		<table border="1" style="width: 100%; border-collapse: collapse;"> <tr> <td colspan="2" style="text-align: center;">THRO. CURV</td> <td style="text-align: right;">THRO. CURV (Page 19)</td> </tr> <tr> <td>IDLE 1</td> <td></td> <td></td> </tr> <tr> <td>I</td> <td style="text-align: center;">20</td> <td></td> </tr> <tr> <td>O</td> <td style="text-align: center;">20</td> <td></td> </tr> <tr> <td>H</td> <td style="text-align: center;">3</td> <td></td> </tr> </table>	THRO. CURV		THRO. CURV (Page 19)	IDLE 1			I	20		O	20		H	3	
THRO. CURV		THRO. CURV (Page 19)																																													
NOR																																															
I	50																																														
O	50																																														
L	75																																														
THRO. CURV		THRO. CURV (Page 19)																																													
IDLE 0																																															
I	20																																														
O	20																																														
H	75																																														
THRO. CURV		THRO. CURV (Page 19)																																													
IDLE 1																																															
I	20																																														
O	20																																														
H	3																																														

MONITOR (Page 19)	

<table border="1" style="width: 100%; border-collapse: collapse;"> <tr> <td colspan="2" style="text-align: center;">PIT. CURV</td> <td style="text-align: right;">PIT. CURV (Page 20)</td> </tr> <tr> <td>NOR</td> <td></td> <td></td> </tr> <tr> <td>I</td> <td style="text-align: center;">0</td> <td></td> </tr> <tr> <td>O</td> <td style="text-align: center;">0</td> <td></td> </tr> <tr> <td>L</td> <td style="text-align: center;">0</td> <td></td> </tr> </table>	PIT. CURV		PIT. CURV (Page 20)	NOR			I	0		O	0		L	0		<table border="1" style="width: 100%; border-collapse: collapse;"> <tr> <td colspan="2" style="text-align: center;">PIT. CURV</td> <td style="text-align: right;">PIT. CURV (Page 20)</td> </tr> <tr> <td>IDLE 0</td> <td></td> <td></td> </tr> <tr> <td>I</td> <td style="text-align: center;">20</td> <td></td> </tr> <tr> <td>O</td> <td style="text-align: center;">20</td> <td></td> </tr> <tr> <td>H</td> <td style="text-align: center;">0</td> <td></td> </tr> </table>	PIT. CURV		PIT. CURV (Page 20)	IDLE 0			I	20		O	20		H	0		<table border="1" style="width: 100%; border-collapse: collapse;"> <tr> <td colspan="2" style="text-align: center;">PIT. CURV</td> <td style="text-align: right;">PIT. CURV (Page 20)</td> </tr> <tr> <td>IDLE 1</td> <td></td> <td></td> </tr> <tr> <td>I</td> <td style="text-align: center;">20</td> <td></td> </tr> <tr> <td>O</td> <td style="text-align: center;">20</td> <td></td> </tr> <tr> <td>H</td> <td style="text-align: center;">75</td> <td></td> </tr> </table>	PIT. CURV		PIT. CURV (Page 20)	IDLE 1			I	20		O	20		H	75	
PIT. CURV		PIT. CURV (Page 20)																																													
NOR																																															
I	0																																														
O	0																																														
L	0																																														
PIT. CURV		PIT. CURV (Page 20)																																													
IDLE 0																																															
I	20																																														
O	20																																														
H	0																																														
PIT. CURV		PIT. CURV (Page 20)																																													
IDLE 1																																															
I	20																																														
O	20																																														
H	75																																														

THRO. HOLD (Page 20)	
SW	ON
VALUE	-20%

3.2 D/R

FUN. MENU	DR	AILE0	DR	AILE0	DR	AILE1
D/R	E	0	R	100	E	0
SUB.TRIM	I	0	I	0	R	100
TRAVLE	O	0	O	0	I	0

DR	AILE0
E	0
R	100
I	0
O	0

AILE DR SW
POS0/POS1



D/R operation for AILE

Operation:

- 1) Press "up" to select "FUN MENU", and press "ENTER" to come to the interface.
- 2) Press "up" or "down" to select 'D/R', and now the shadow area is the item that can be set currently. Press "ENTER" to go to the next step.
- 3) Press "A/E/R D/R" to select 'AILE D/R', and LCD shows the corresponding "AILE 0" or "AILE 1".
- 4) Move "up" or "down" to select 'E' or 'O', and press "INC" or "DEC" to set the corresponding value and dual band curve will change accordingly.
- 5) Set "AILE D/R" switch on the top of the transmitter
When "A/E/R D/R" is in '0' position, LCD shows "AILE 0", and now you can set D/R value for "AILE 0".
And when "A/E/R D/R" is in '1' position, LCD shows "AILE 1", and now you can set D/R value for "AILE 1".

6) After your setting, press "EXIT" to save the setting and leave the operation.

DR	ELEV1
E	0
R	100
I	0
O	0

ELEV DR SW
POS0/POS1



D/R operation for ELEV

Operation:

- 1) Press "up" to select "FUN MENU", and press "ENTER" to come to the interface.
- 2) Press "DEC" or "INC" to select 'D/R', and now the shadow area is the item that can be set currently. Press "ENTER" to Elev D/R.
- 3) Move "up" or "down" button to select 'E' or 'O', and press "INC" or "DEC" to set the corresponding value and.
- 4) Set "ELEV D/R" switch on the top of the transmitter
When "A/E/R D/R" is in '0' position, LCD shows "ELEV 0", and now you can set D/R value for "ELEV 0".
And when "A/E/R D/R" is in '1' position, LCD shows "ELEV 1", and now you can set D/R value for "ELEV 1".
- 5) After your setting, press "EXIT" to save and leave the operation.

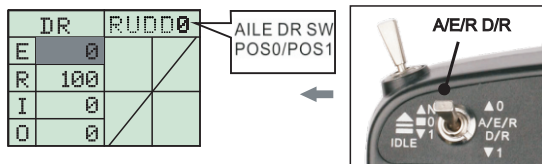

D/R operation for RUDD

Operation:

- 1) Press “up” to select “FUN MENU” ,and press “ENTER” to come to the interface.
- 2) Press “up” or “down” to select ‘D/R’ ,and now the shadow area is the item that can be set currently.Press “ENTER” to go to the next step.
- 3) Press “up” or “down” to select ‘E’ or ‘O’ ,and press “INC” or “DEC” to set the corresponding value and dual band curve will change accordingly.
- 4) Set “RUDD D/R” switch on the top of the transmitter
When “A/E/R D/R” is in ‘0’ position,LCD shows “RUDD 0” ,and now you can set D/R value for “RUDD 0” .
And when “A/E/R D/R” is in ‘1’ position,LCD shows “RUDD 1” ,and now you can set D/R value for “RUDD 1” .
- 5) After you setting,press “EXIT” to save the setting and leave the operation.

Remark:There is no shortcut key on the surface of the transmitter,D/R data is only one group,please note.

3.3 SUB Trim

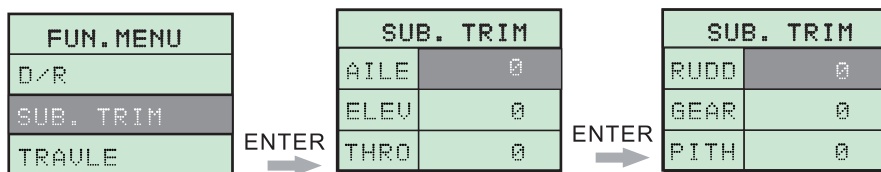

Channel neutral trim operation

Operation:

- 1) Press “up” to select “FUN MENU” ,and press “ENTER” to come to the interface.
- 2) Press “DEC” or “INC” to select “SUB TRIM” ,and now the shadow area is the item that can be set currently.Press “ENTER” to go to the next step.
- 3) Press “up” or “down” to select 'AILE','ELEV','THRO','RUDD','GEAR','PITCH'.
- 4) Press “INC” or “DEC” to set the value of channel neutral trim.
- 5) After your setting,press “EXIT” to save the setting and leave the operation.

3.4 Travel

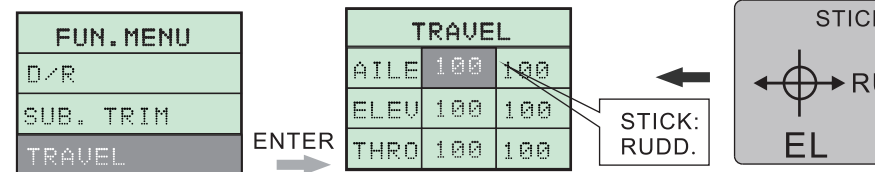

Travel operation

Operation:

- 1) Press “up” to select “FUN MENU” ,and press “ENTER” to come to the interface.
- 2) Press “up” or “down” to select “TRAVEL” ,and now the shadow area is the item that can be set currently.Press “ENTER” to go to the next step.
- 3) Press “ENTER” to select 'AILE','ELEV','THRO','RUDD','GEAR','PITCH'.Press “up” or “down” to select the plus or minus travel value.
- 4) Press “INC” or “DEC” to set the travel value.
- 5) After you setting,press “EXIT” to save the setting and leave the operation.

3.5 CH.Rev

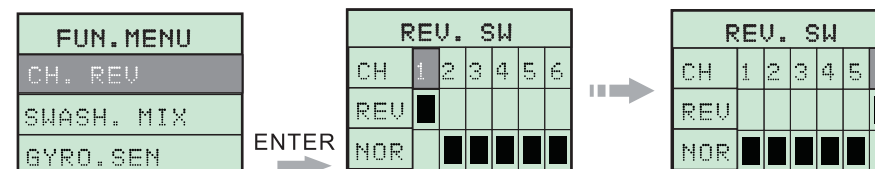

Channel reverse operation

Operation:

- 1) Press “up” to select “FUN MENU” ,and press “ENTER” to come to the interface.
- 2) Press “up” or “down” to select “CH REV” ,and now the shadow area is the item that can be set currently.Press “ENTER” to go to the next step.
- 3) Press “ENTER” to select 'AILE','ELEV','THRO','RUDD','GEAR','PITCH'.Use 1.2.3.4.5.6 to replace the channels.
- 4) Press “INC” to set the reverse mode and “DEC” to set normal mode.
REV is reverse
NOR is normal
- 5) After your setting,press “EXIT” to save the setting and leave the operation.

3.6 Swash.Mix

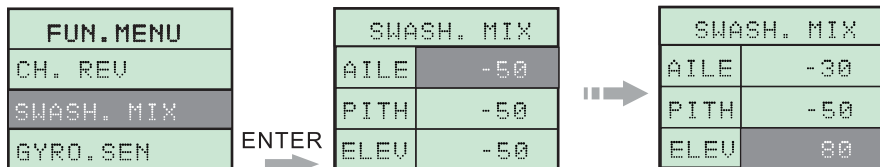

✍ Swash mix (only for CCPM three servos 120° helicopter)

Operation:

- 1) Press “up” to select “FUN MENU” ,and press “ENTER” to come to the interface.
- 2) Press “up” or “down” to select “SWASH MIX” ,and now the shadow area is the item that can be set currently.Press “ENTER” to go to the next step.
- 3) Press “up” or “down” to select ‘AILE’,‘PITCH’,‘ELEV’.
- 4) Press “INC” or “DEC” to set the value of each channel.
- 5) After you setting,press “EXIT” to save the setting and leave the operation.

3.7 GYRO.Sens

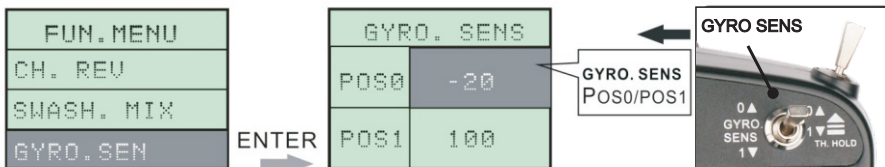

✍ Gyro sensitivity adjustment

Operation:

- 1) Press “up” to select “FUN MENU” ,and press “ENTER” to come to the interface.
- 2) Press “up” or “down” to select ‘GYRO SENS’ ,and now the shadow area is the item that can be set currently.Press “ENTER” to go to the next step.
- 3) Set “GYRO SENS” switch on the top of the transmitter.
When “GYRO SENS” is in “0” position,LCD shows “POS 0” ,and now you can set the value for “POS 0” by “INC” or “DEC” .
When “GYRO SENS” is in “1” position,LCD shows “POS 1” ,and now you can set the value for “POS 1” by “INC” or “DEC” .
- 4) After your setting,press “EXIT” to save the setting and leave the operation.

3.8 Thro.Curve

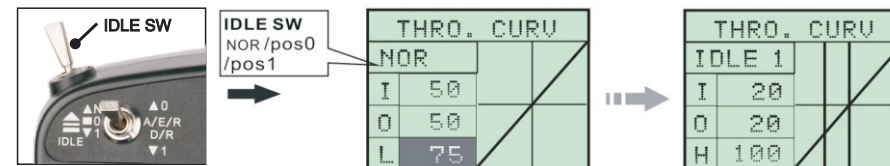

✍ Throttle curve operation

Operation:

- 1) Press “up” to select “FUN MENU” ,and press “ENTER” to come to the interface.
- 2) Press “up” or “down” to select “THRO CURV” ,and now the shadow area is the item that can be set currently.Press “ENTER” to go to the next step.
- 3) Press “ENTER” to select the throttle curve point.There are 5 points,they are L,1,2,3,H. Press “INC” or “DEC” to set the corresponding value separately,and the throttle curve will change accordingly.
- 4) There are three throttle curves to be selected,normal, “IDLE 0” and “IDLE 1” by the switch at the left top of the transmitter..
- 5) After your setting,press “EXIT” to save the setting and leave the operation.

Remark:the transmitter can save 3 groups of different throttle curves.When you make 3D fly, please ask for instruction from experienced pilots.

3.9 Monitor

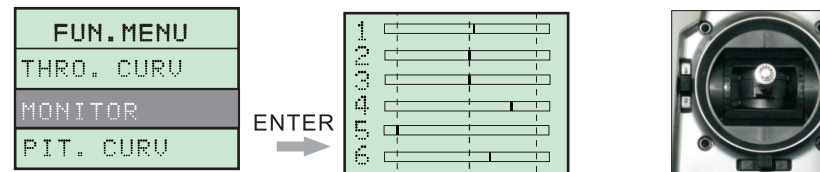

✍ Monitor system

Operation:

- 1) Press “up” to select “FUN MENU” ,and press “ENTER” to come to the interface.
- 2) Press “up” or “down” to select “MONITOR” ,and now the shadow area is the item that can be set currently.Press “ENTER” to go to the next step.
- 3) When you move the sticks or channel switches,you can find the corresponding channel bars will change accordingly.This function is designed to monitor the working conditions of the transmitter.
- 4) After your setting,press “EXIT” to save the setting and leave the operation.

Remark:this function helps you adjust the setting,neutral trim as well as channel inspection.

3.10 Pit. Curve

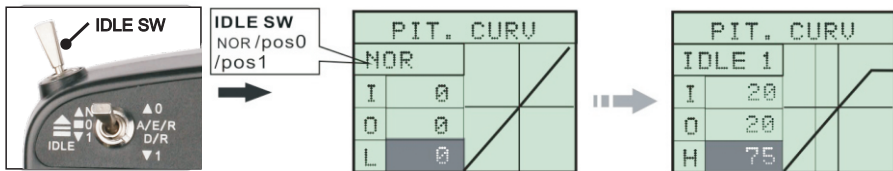

Pitch curve

Operation:

- 1) Press "up" to select 'FUN MENU', and press "ENTER" to come to the interface.
- 2) Press "up" or "down" to select "PIT CURV", and now the shadow area is the item that can be set currently. Press "ENTER" to go to the next step.
- 3) Press "ENTER" to select the pitch curve point. There are 5 points, they are L, 1, 2, 3, H. Press "INC" or "DEC" to set the corresponding value separately, and the pitch curve will change accordingly.
- 4) There are three pitch curves to be selected, normal, "IDLE 0" and "IDLE 1" by the switch at the left top of the transmitter.
- 5) After you setting, press "EXIT" to save the setting and leave the operation.

Remark: the transmitter can save 3 groups of different pitch curves. When you fly 3D, please ask for instruction from experienced pilots.

3.11 Thro. Hold

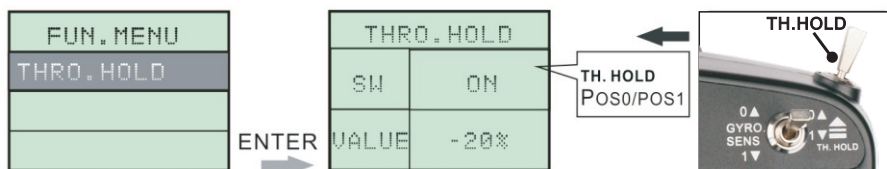

Throttle hold

Operation:

- 1) Press "up" to select 'FUN MENU', and press "ENTER" to come to the interface.
- 2) Press "up" or "down" to select 'THRO HOLD', and now the shadow area is the item that can be set currently. Press "ENTER" to go to the next step.
- 3) Set the "TH HOLD" switch at the top of the transmitter.
When "TH HOLD" is in '0' position, LCD show SW "OFF"; When "TH HOLD" is in '1' position, LCD show SW "ON".
- 4) After your setting, press "EXIT" to save the setting and leave the operation.

4.1 Function menu for fixed wing plane

The menu includes: DR, sub-Trim, servo travel, channel reverse, stick monitor. Please see the corresponding description in the helicopter function menu for the operation.

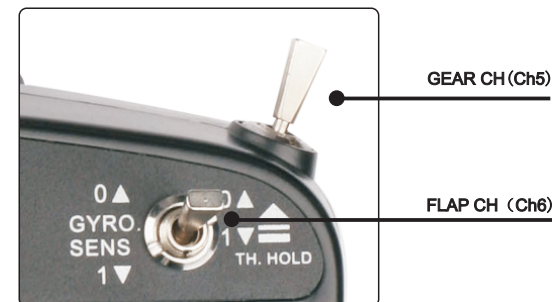

4.2 V-Tail function menu

V-Tail function menu includes: DR, sub-Trim, servo travel, channel reverse, monitor. Please see the corresponding description in the helicopter function menu for the operation.

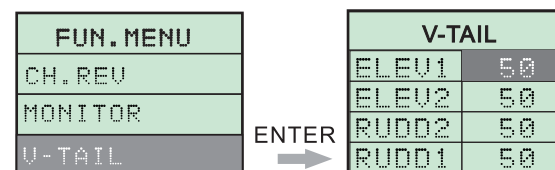

V-Tail mixing

Operation (plane type is V-Tail):

- 1) Press "up" to select "FUN MENU", and press "ENTER" to come to the interface.
- 2) Press "up" or "down" to select "V-Tail", and now the shadow area is the item that can be set currently. Press "ENTER" to go to the next step.
- 3) Press "ENTER" to select "ELEV 1", "ELEV 2", "RUDD 1", "RUDD 2". and set the mixing value by "up" or "down".
- 4) After your setting, press "EXIT" to save and leave the operation.

4.3 Delta mix function menu

Delta mix function menu includes:DR,sub-Trim,servo travel,channel reverse,monitor. Please see the corresponding description in the helicopter function menu for the operation.

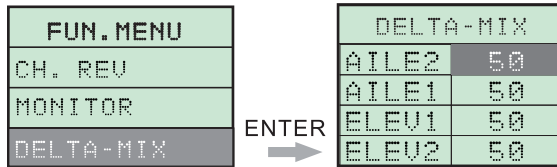

✍ Delta mix setting

Operation(plane type is DELTA-MIX):

- 1)Press “up” to select “FUN MENU” ,and press “ENTER” to come to the interface.
- 2)Press “up” or “down” to select “DELTA-MIX” ,and now the shadow area is the item that can be set currently.Press “ENTER” to go to the next step.
- 3)Press “up” or “down” to select ‘AILE2’ , ‘AILE1’ , ‘ELE2’ , ‘ELEV2’ .and set the mixing value by “INC” or “DEC” .
- 4)After your setting,press “EXIT” to save the setting and leave the operation.

5.1 Heli. Connection Diagram(3Servos CCPM)

✍ Switch to “HELI” position and enter Helicopter mode.

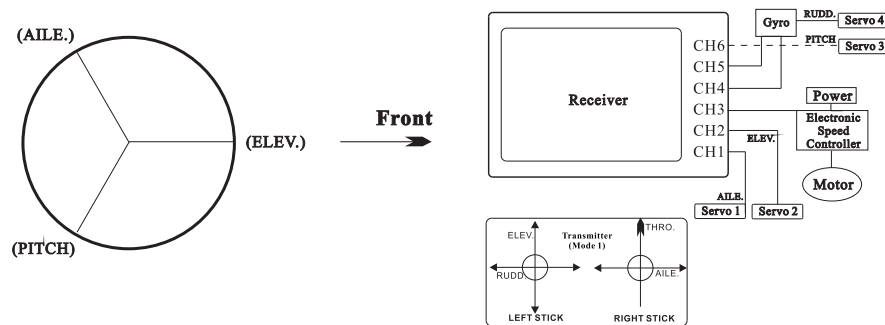

5.2 Airplane Connection Diagram

✍ Switch to “plane” position and enter Airplane mode, not mix function, as for normal planes.

✍ Receiver channel distribution:

- CH1: Aileron
- CH2: Elevator
- CH3: Throttle
- CH4: Rudder
- CH5: Gear
- CH6: Flap

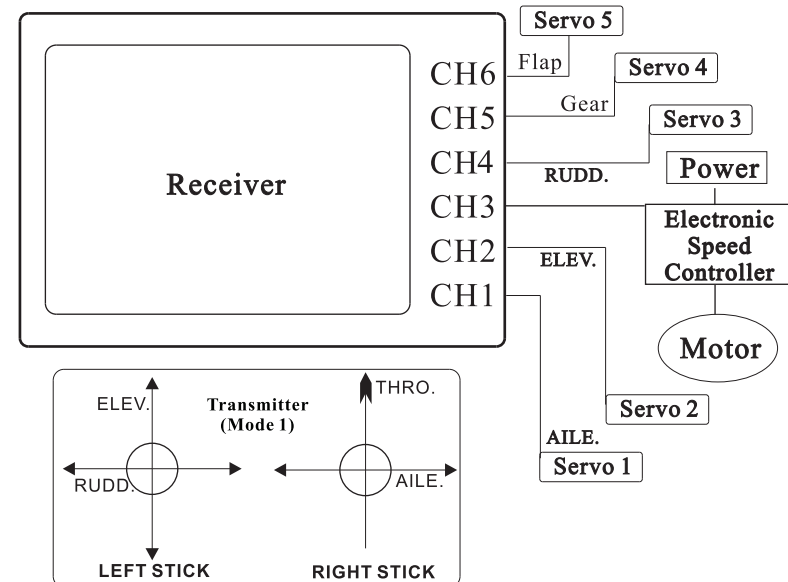
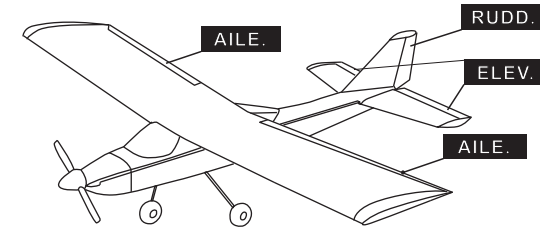

5.3 V-Tail Connection Diagram

Transmitter	Receiver channel mixing	
Stick	Ch2	Ch4
Elevator Stick	+50%	-50%
Rudder Stick	+50%	+50%

- ✍ Switch to “V-Tail” position and enter V-Tail mode, elevator and Rudder is mixed, as for V-Tail planes.
- ✍ Receiver channel distribution:
CH1: Aileron
CH2: Elevator
CH3: Throttle
CH4: Rudder
CH5: Aileron2

5.4 DELTA-MIX Connection Diagram

Transmitter	Receiver channel mixing		
Stick	Ch1	Ch2	Ch5
Aileron Stick	+50%	+50%	+50%
Elevator Stick	+50%	-50%	+50%

- ✍ Switch to “DELTA” position and enter DELTA-mix mode, aileron and elevator is mixed, as for triangle planes, tailless planes, discal planes.
- ✍ Receiver channel distribution:
CH1: Aileron
CH2: Elevator
CH3: Throttle
CH4: Rudder
CH5: Aileron2



DIGITAL PROPORTIONAL RC SYSTEM

Technology Data

Transmitter

FC CE 0678

Receiver 1

Type: X-6S
Specification: LCD
Modulation: GFSK
Channels: 6
Frequency: 2.4GHz
Working current: ≤ 150mA
Measurement:
200x185x105 mm(packing meas.)

Type: XY7000S
Code format: PCM
Channels: 7
Frequency: 2.4G
DC: 4.5~9.6v, ≤30mA
Net weight: 11.5g

This device complies with part 15 of the FCC rules. Operation is subject to the following two conditions
(1) this device may not cause harmful interference, and
(2) this device must accept any interference received, including interference that may cause undesired operation.

Changes or modifications not expressly approved by the party responsible for compliance could void the user's authority to operate the equipment.

Due to unforeseen changes in production procedures, the information contained in this manual is subject to change without notice.